

SPAJ 140 C

Overcurrent and earth-fault relay

User's manual and Technical description

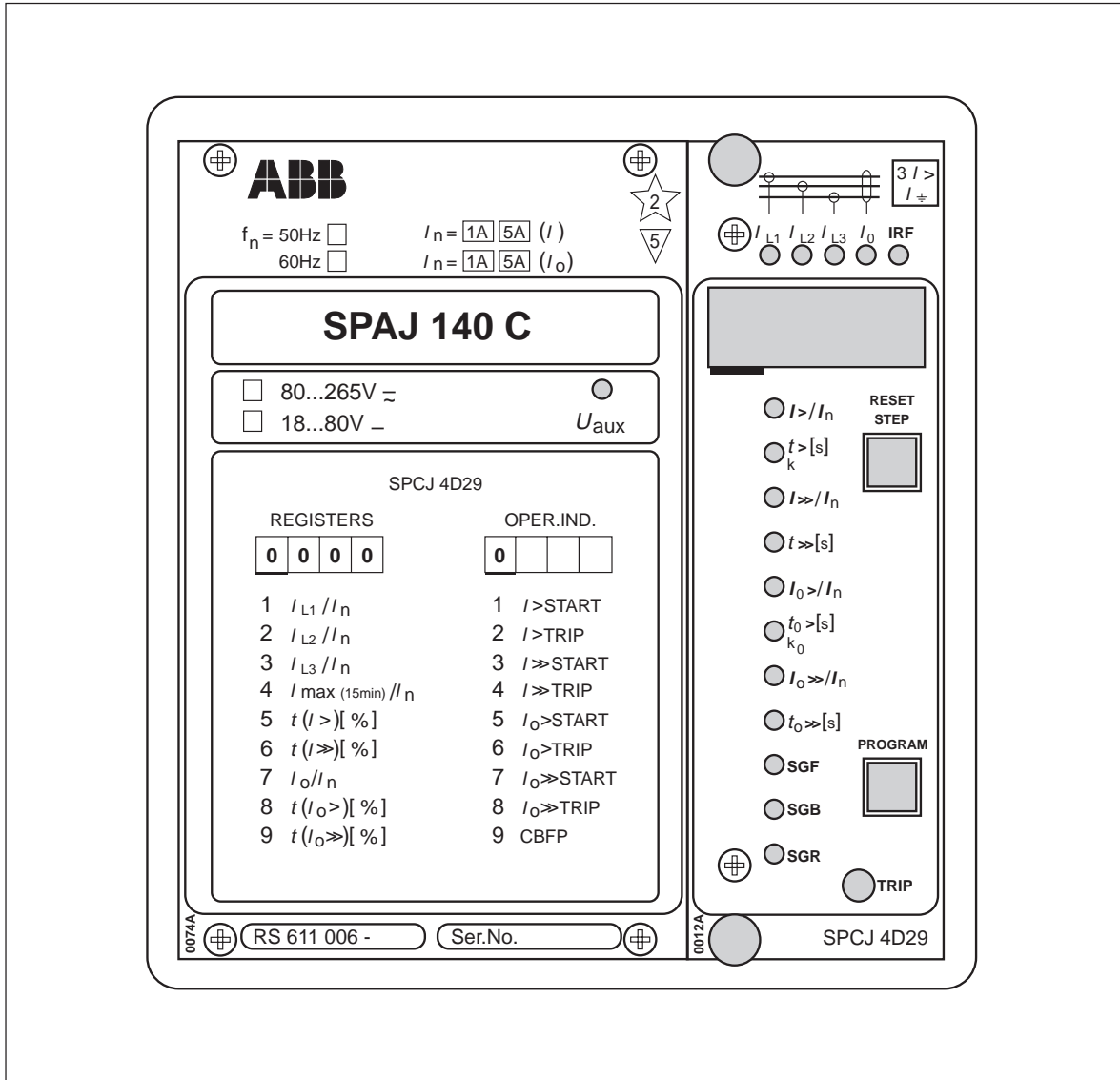

SPAJ 140 C

Combined overcurrent and earth-fault relay

Data subject to change without notice

Contents	Features	2
	Application	2
	Description of operation	3
	Connections (<i>modified 2003-09</i>)	4
	Signal diagram	7
	Signal abbreviations	7
	Start and operation indicators	8
	Power supply and output relay module	9
	Technical data (<i>modified 2007-02</i>)	10
	Maintenance and repairs	13
	Spare parts	13
	Dimensions and instructions for mounting	14
	Order information	14

The complete manual for the relay SPAJ 140 C contains the following submanuals:

General relay description for SPAJ 140 C	1MRS 750629
General characteristics of D type relay modules	1MRS 750066-MUM EN
Combined overcurrent and earth-fault relay module type SPCJ 4D29	1MRS 750119

Features	Three-phase, low-set phase overcurrent unit with definite time or inverse definite minimum time (IDMT) characteristic	Extensive data communication capabilities over built-in serial port
	Three-phase, high-set phase overcurrent unit with instantaneous or definite time function	Outstanding design flexibility for easy selection of appropriate operation schemes for different applications
	Low-set, non-directional earth-fault unit with definite time or inverse definite minimum time (IDMT) characteristic	Numerical display of setting values, measured values, memorized fault values, fault codes etc.
	High-set, non-directional earth-fault unit with instantaneous or definite time function	Enhanced system reliability and availability due to continuous hardware and software self-supervision with auto-diagnosis
	Built-in breaker failure protection function	Powerful software support for setting and parametrizing of the relay and for recording of relay parameters with a portable PC.
	Two heavy-duty and four light-duty output relays with field-selectable configuration	

Application	The combined overcurrent and earth-fault relay SPAJ 140 C is intended to be used for the selective short-circuit and earth-fault protection of radial feeders in solidly earthed, resistance earthed or impedance earthed power systems. The integrated protection relay includes a phase overcurrent unit and an earth-fault unit with	flexible tripping and signalling facilities. The overcurrent and earth-fault relays can also be used in other applications requiring single-, two- or three-phase overcurrent protection and non-directional earth-fault protection. The combined overcurrent and earth-fault relay also features circuit breaker failure protection.
--------------------	---	---

Description of operation

The combined overcurrent and earth-fault relay is a secondary relay to be connected to the current transformers of the protected object. The three-phase overcurrent unit and the earth-fault unit continuously measure the phase currents and the neutral current of the protected object. On detection of a fault the relay starts, trips the circuit breaker, initiates auto-reclosing, provides alarm, records fault data etc. in accordance with the application and the configured relay functions.

When the phase current exceeds the set start current of the low-set stage $I_{>}$, the overcurrent unit starts delivering a start signal after a preset ~ 60 ms start time. When the set operate time at definite time operation or the calculated operate time at inverse time operation elapses, the overcurrent unit operates. In the same way the high-set stage $I_{>>}$ of the overcurrent unit starts delivering a start signal after a preset ~ 40 ms start time, when the set start current is exceeded. When the set operate time elapses, the overcurrent unit operates.

When the earth-fault current exceeds the set start current of the low-set stage $I_{0>}$, the earth-fault unit starts delivering a start signal after a preset ~ 60 ms start time. When the set operate time at definite time operation or the calculated operate time at inverse time operation elapses, the earth-fault unit operates. In the same way the high-set stage $I_{0>>}$ of the earth-fault unit

starts delivering a start signal after a preset ~ 40 ms start time, when the set start current is exceeded. When the set operate time elapses, the earth-fault unit operates.

The low-set stage of the overcurrent unit and the low-set stage of the earth-fault unit may be given definite time or inverse definite minimum time (IDMT) characteristic. When the IDMT characteristic is chosen six time/current curves are available. Four of the curves comply with the BS 142 and IEC 60255 and are named "Normal inverse", "Very inverse", "Extremely inverse" and "Long-time inverse". The two additional inverse time curves called the "RI-curve" and the "RXIDG-curve" are also provided.

By appropriate configuration of the output relay matrix, the start signals of the overcurrent and earth-fault units are obtained as contact functions. The start signals can be used for blocking co-operating protection relays, for signalling and for initiating auto-reclosing.

The relay includes one external binary input, which is controlled by an external control voltage. The function of the control input is determined by selector switches in the protection relay module. The control input can be used for blocking the operation of one or more protection stages, for resetting a latched output relay in the manual reset mode or for enforcing a new set of relay setting parameters by remote control.

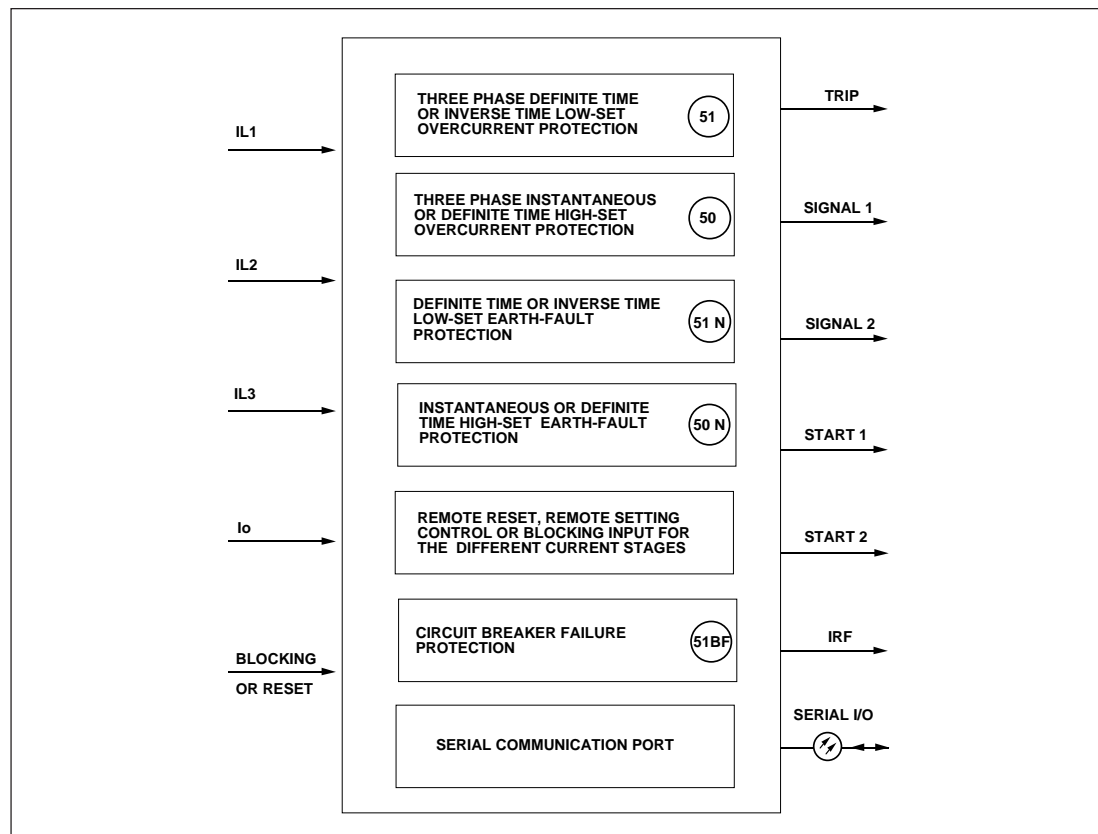

Fig. 1. Protection functions of the combined overcurrent and earth-fault relay type SPAJ 140 C.

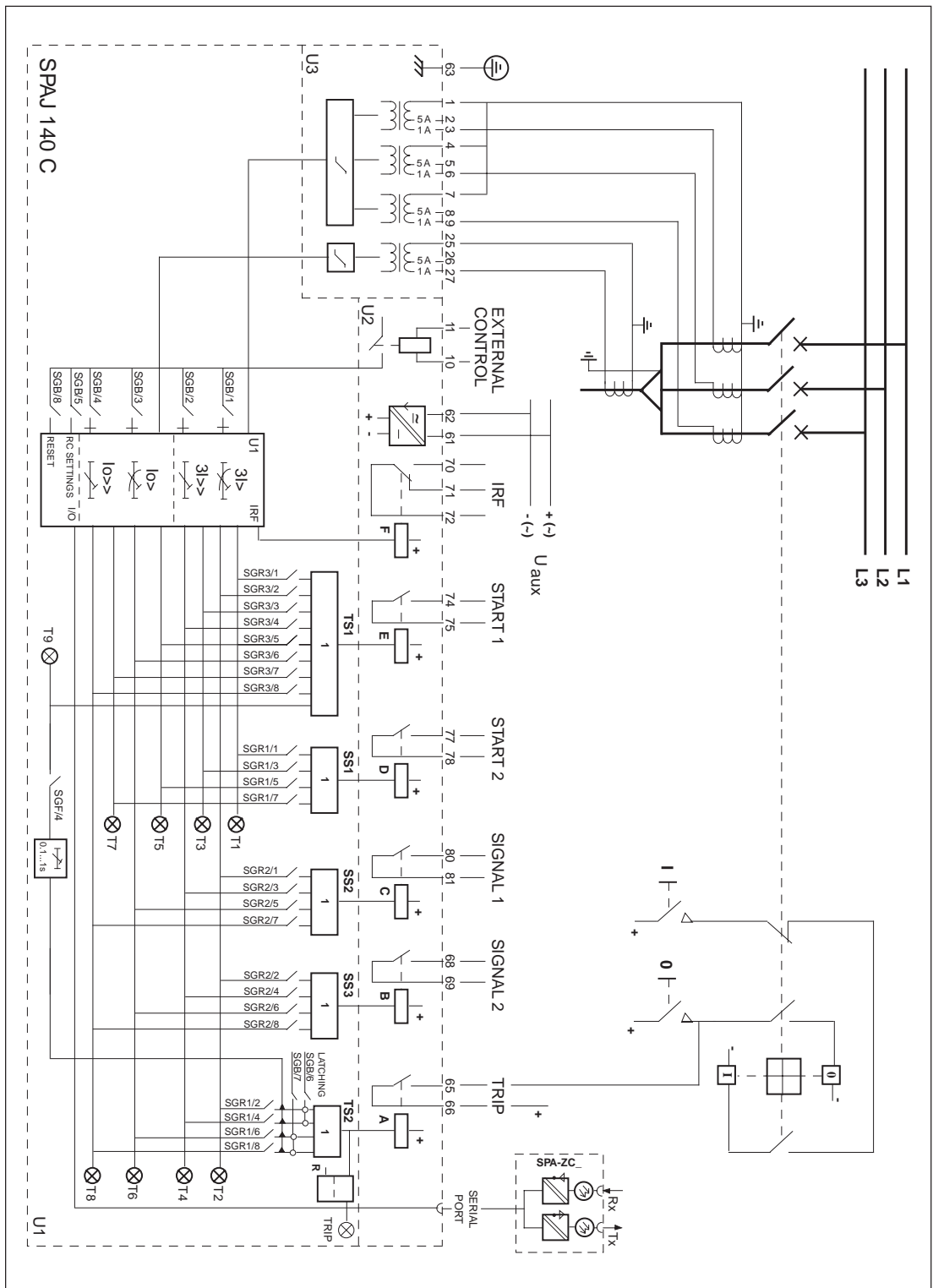

Fig. 2. Connection diagram for the combined overcurrent and earth-fault relay type SPAJ 140 C.

U_{aux}	Auxiliary voltage
A, B, C, D, E, F	Output relays
IRF	Self-supervision
SGR	Switchgroups for the configuration of the output relays
SGB	Switchgroup for the configuration of the blocking or control signal
TRIP	Trip output relay
SIGNAL 1	Signal on operation of the overcurrent unit
SIGNAL 2	Signal on operation of the earth-fault unit
START 1	Starting or auxiliary trip signal as selected with switchgroup SGR3
START 2	Start signal of the low-set overcurrent stage I>
U1	Overcurrent and earth-fault relay module SPCJ 4D29
U3	Input module SPTE 4E1
U2	Power supply and output relay module SPTU 240 R1 or SPTU 48 R1
T1...T9	Start and operation indications
SERIAL PORT	Serial communication port
SPA-ZC_	Bus connection module
Rx/Tx	Receiver bus terminal (Rx) and transmitter bus terminal (Tx) of the bus connection module

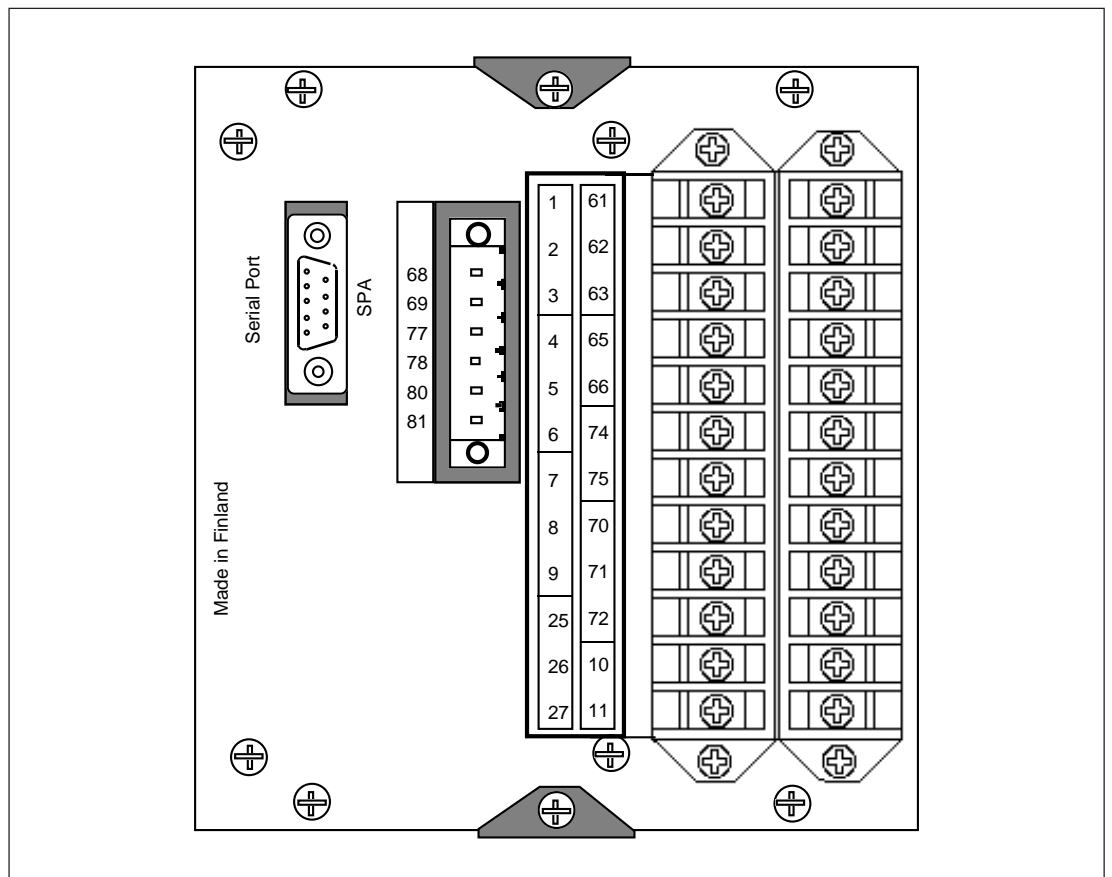

Fig. 3. Terminal arrangement of the overcurrent and earth-fault relay type SPAJ 140 C.

The energizing currents of the overcurrent unit are connected to terminals 1-2, 4-5 and 7-8, when the rated current of the CT secondary circuits is $I_n = 5$ A. When the rated current of the CT secondary circuits is $I_n = 1$ A, terminals 1-3, 4-6 and 7-9 are used. The relay can also be used in single-phase or two-phase applications simply by leaving one or two energizing inputs unoccupied. In single-phase applications the same energizing current can be routed through two energizing inputs, which may increase the operating speed of the overcurrent unit, especially at instantaneous operation.

The energizing current for the earth-fault unit is connected to terminals 25-26 when the rated current $I_n = 5$ A and to terminals 25-27 when the rated current $I_n = 1$ A.

The control input 10-11 can be used in three different ways, i) as control input for an external blocking signal, ii) as the control input for unlatching the trip relay, or iii) as the control input for the remote control of relay settings. The requested function is selected by means of switches switchgroup SGB in the main menu of the protection relay module.

The auxiliary supply voltage of the relay is connected to terminals 61-62. At d.c. supply the positive lead is connected to terminal 61. The level of the voltage to be applied to the terminals depends on the type of power supply and output relay module inserted in the relay. For further details see the description of the power supply module. The permitted auxiliary voltage range of the relay is marked on the relay front panel.

Output relay A is a heavy-duty trip relay capable of controlling most circuit breakers. The operate signals of the different protection stages are routed to the trip relay with switches 2,4,6 and 8 of switchgroup SGR1. On delivery from the factory all the protection stages are routed to the trip relay. A latching of the output relay A can be selected with switches 6 and 7 of switchgroup SGB.

Output relays B and C can be used for signalling on operation of the relay module. The signals to be routed to the output relays B and C are

selected with switches 1...8 of switchgroup SGR2. The switch matrixes for routing operate signals to the output relays B and C are identical. Normally output relay B is used for signalling on operation of the overcurrent unit and C for signalling on operation of the earth-fault unit. This is also the default setting of the relay on delivery from the factory.

The start signals of the protection stages of the relay are routed to output relay D. The signals to be routed to output relay D are selected by means of switches 1, 3, 5 and 7 of switchgroup SGR1, which is a software switchgroup found in the main menu of the protection relay module. The start signals of the low-set and high-set stage of the overcurrent unit are selected with switches 1 and 3, and the start signals of the high-set and low-set stage of the earth-fault unit with switches 5 and 7.

The output relay E is a heavy-duty relay as output relay A. It can be controlled by the start and operate signals of the protection stages. Output relay E is also used as a trip relay for the circuit breaker failure protection (CBFP), when the CBFP protection is used. In this case the trip signal can be used either to control a circuit breaker upstreams or to control a second trip coil on the main circuit breaker to increase the redundancy of the circuit breaker.

Output relay F functions as output relay for the self-supervision system of the protection relay. The F relay is energized under normal operating conditions and contact gap 70-72 is closed. If a fault is detected by the self-supervision system, or on loss of auxiliary supply, the output relay drops off and the NO contact 71-72 closes.

By means of bus connection modules type SPA -ZC17 and SPA-ZC21 the relay connects to the fibre-optic SPA bus via a 9-pole, D-type subminiature connector located at the rear panel of the relay. The terminals of the fibre-optic cables are connected to the counter terminals Rx (receiver) and Tx (transmitter) of the bus connection module. The fibre-optic cables are linked from one relay to another and to the substation level communication unit, for instance type SRIO 1000M.

Signal diagram

The figure below schematically illustrates how the start, trip, control and blocking signals can be configured to obtain the required protection functions.

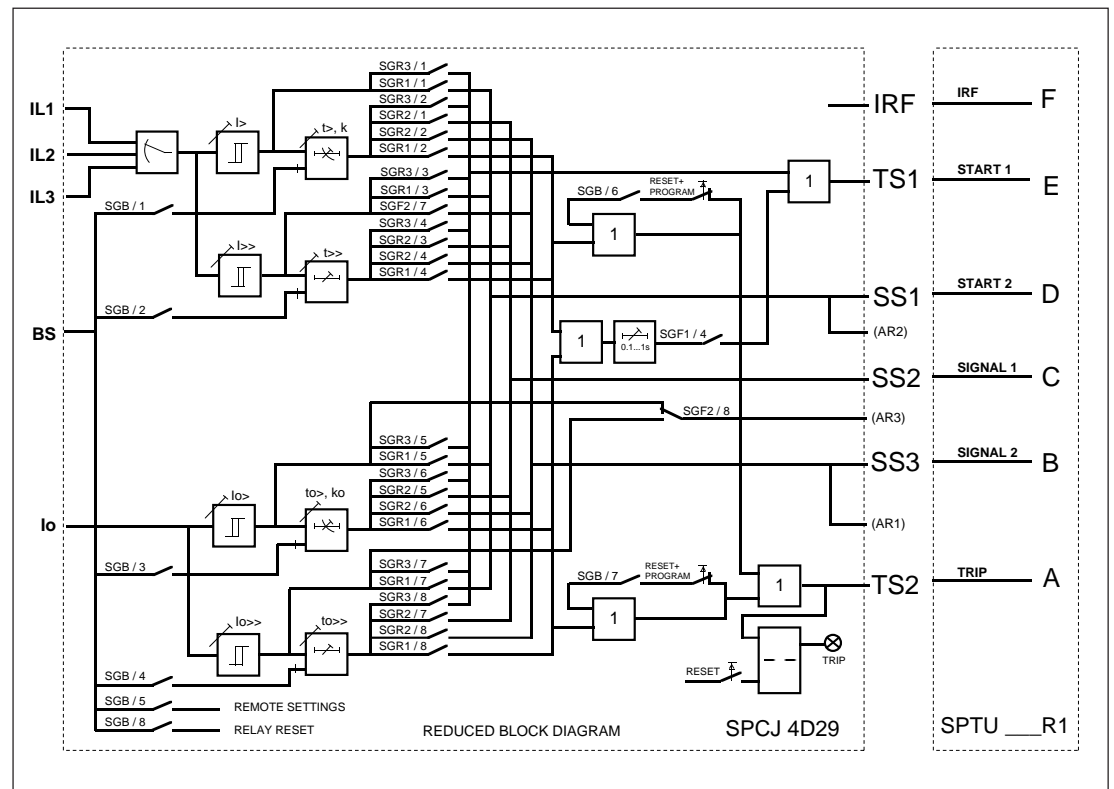

Fig. 4. Signal diagram of the combined overcurrent and earth-fault relay type SPAJ 140 C

The functions of the blocking and start signals are selected with the switches of switchgroups SGF, SGB and SGR. The checksums of the switchgroups, are found in the setting menu of the protection relay module. The functions of the different switches are explained in detail in the user's manual of the protection relay module SPCJ 4D29.

Signal abbreviations

I_{L1}, I_{L2}, I_{L3}	Energizing current of phase L1, L2 and L3
I_0	Neutral current (Residual current)
BS	Blocking or control signal
SS1	Start signal 1
SS2	Start signal 2
SS3	Start signal 3
TS1	Operate signal 1 (Trip signal 1)
TS2	Operate signal 2 (Trip signal 2)
BS	Blocking signal
AR1...3	Auto-reclose start signals (not in use in relay SPAJ 140 C)
IRF	Internal relay failure
SGF	Switchgroup for functions
SGB	Switchgroup for blockings
SGR	Switchgroup for relay configuration

Operation indicators

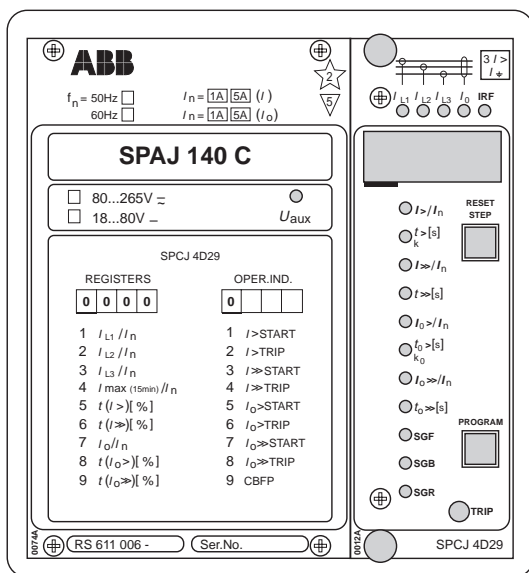

- A) The indicator TRIP is lit when one of the protection stages operates. When the protection stage resets, the red indicator remains lit.
- B) If the display is dark when one of the protection stages $I>$, $I>>$, $I_0>$ or $I_0>>$ operates, the faulty phase or the neutral circuit is indicated with a yellow LED. If, for instance, the TRIP indicator glows red, and the indicators I_{L1} and I_{L2} at the same time are lit, overcurrent has occurred on phase L1 and L2.
- C) Besides being a code number at data presentation, the leftmost red digit in the display serves as a visual operation indicator. An operation indicator is recognized by the fact that the red digit alone is switched on. The following table named OPERATION IND. on the relay front panel is a key to the function code numbers used.

Indication	Explanation
1	$I>$ START = The low-set stage $I>$ of the overcurrent unit has started
2	$I>$ TRIP = The low-set stage $I>$ of the overcurrent unit has operated
3	$I>>$ START = The high-set stage $I>>$ of the overcurrent unit has started
4	$I>>$ TRIP = The high-set stage $I>>$ of the overcurrent unit has operated
5	$I_0>$ START = The low-set stage $I_0>$ of the earth-fault unit has started
6	$I_0>$ TRIP = The low-set stage $I_0>$ of the earth-fault unit has operated
7	$I_0>>$ START = The high-set stage $I_0>>$ of the earth-fault unit has started
8	$I_0>>$ TRIP = The high-set stage $I_0>>$ of the earth-fault unit has operated
9	CBFP = Circuit breaker failure protection has operated

D) The TRIP indications persist when the protection stage returns to normal. The indicator is reset by pushing the RESET/STEP push-button.

- SGF2/1 = 1 manual reset of $I>$ start indication
 SGF2/2 = 1 manual reset of $I>>$ start indication
 SGF2/3 = 1 manual reset of $I_0>$ start indication
 SGF2/4 = 1 manual reset of $I_0>>$ start indication

Further, the indicators may be reset via the external control input 10-11 by applying a control voltage to the input, provided switch SGB/8 is in position 1.

On delivery of the relay from the factory the switches SGF2/1...4 are preset at 0.

The basic protection relay functions are not depending on the state of the operation indicators, reset or non-reset. The relay is permanently operative.

E) Shortly after the internal self-supervision system has detected a permanent relay fault the red IRF indicator is switched on and the output relay of the self-supervision system operates. Further, in most fault situations an autodiagnostic fault code is shown in the display. The fault code is composed of a red figure 1 and a green code number which indicates fault type. The fault code persists until the STEP/RESET push-button is pressed. When a fault code appears on the display, the code number should be recorded for statistical and maintenance purposes.

If a protection stage starts, but not operates, because the energizing quantity goes below the set start current before the operate time circuit has timed out, the start indicators are normally automatically switched off. However, by means of the switches SGF2/1...4 the start indications may be made persistent which means that they are to be manually reset by pushing the RESET/STEP push-button. The persistent indications are obtained through the following switch settings.

Power supply and output relay module

To be able to operate the relay needs a secured auxiliary voltage supply. The power supply module forms the voltages required by the protection relay module and the auxiliary relays. The withdrawable power supply and output relay module is located behind the system front panel, which is fixed by means of four cross-slotted screws. The power supply and output relay module contains the power supply unit, all output relays, the control circuits of the output relays and the electronic circuitry of the external control inputs.

The power supply and output relay module can be withdrawn after removing the system front

panel. The primary side of the power supply module is protected with a fuse, F1, located on the PCB of the module. The fuse size is 1 A (slow).

The power supply unit is a pulse-width modulated (PWM) dc/dc converter with galvanically isolated primary and secondary sides. It forms the dc secondary voltages required by the protection relay module; that is +24 V, ± 12 V and +8 V. The output voltages ± 12 V and +24 V are stabilized in the power supply module, while the +5 V logic voltage required by the protection relay module is stabilized in the protection relay module.

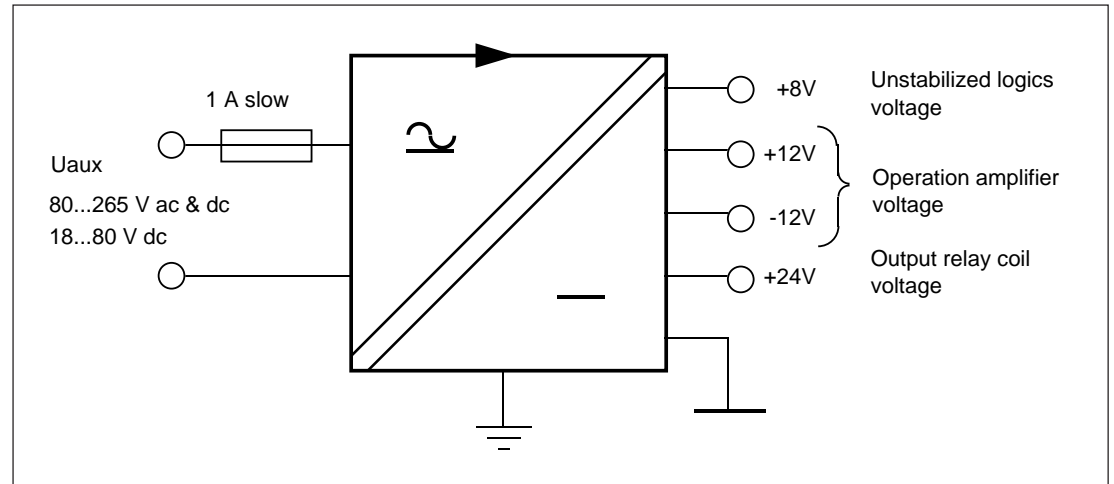

Fig. 5. Voltage levels of the power supply unit

A green LED indicator U_{aux} on the system front panel is lit when the power supply module is in operation. The supervision of the voltages supplying the electronics is located in the protection relay module. If a secondary voltage differs too much from its rated value, a self-supervision alarm will be generated. An alarm is also issued when the power supply module is withdrawn from the relay case, or on loss of auxiliary supply.

There are two versions of power supply and output relay modules available. For both types, the secondary sides and the relay configurations are identical, but the input voltage ranges differ.

Insulation test voltage between the primary and secondary side and the protective earth
2 kV, 50 Hz, 1 min

Rated power P_n 5 W

Voltage ranges of the power supply modules:
- SPTU 240 R1 $U_{aux} = 80...265$ V dc/ac
- SPTU 48 R1 $U_{aux} = 18...80$ V dc

The SPTU 240 R1 module can be fed from either an ac source or a dc source. SPTU 48 R1 is designed for dc supply only. The permitted auxiliary voltage range of the relay is marked on the relay system front panel.

Technical data
(modified 2002-04)

Energizing inputs

Rated current I_n	1 A	5 A
Thermal withstand capability		
- continuously	4 A	20 A
- for 1 s	100 A	500 A
Dynamic current withstand, half-wave value	250 A	1250 A
Input impedance	<100 m Ω	<20 m Ω
Rated frequency f_n , on request		50 Hz or 60 Hz

Output contact ratings

Tripping contacts	
Terminals	65-66, 74-75
Rated voltage	250 V dc/ac
Continuous carry	5 A
Make and carry for 0.5 s	30 A
Make and carry for 3.0 s	15 A
Breaking capacity for dc, when the trip circuit time-constant $L/R \leq 40$ ms, at 48/110/220 V dc	5 A/3 A/1 A
Signalling contacts	
Terminals	70-71-72, 68-69, 77-78, 80-81
Rated voltage	250 V dc/ac
Continuous carry	5 A
Make and carry for 0.5 s	10 A
Make and carry for 3.0 s	8 A
Breaking capacity for dc, when the signal circuit time-constant $L/R \leq 40$ ms, at 48/110/220 V dc signal circuit voltage	1 A/0.25 A/0.15 A

External control inputs

Blocking, remote reset or remote setting input	10-11
Control voltage level	18...265 V dc or 80...265 V ac
Control current of activated input	2...20 mA

Power supply and output relay module

Supply and output relay module, type SPTU 240 R1	80...265 V dc/ac
Supply and output relay module, type SPTU 48 R1	18...80 V dc
Power consumption under quiescent/operating conditions	-4 W/ -6 W

Overcurrent unit of SPCJ 4D29

Low-set overcurrent stage I> *

Start current **

- at definite time characteristic 0.5...5.0 x I_n
- at inverse time characteristic *** 0.5...2.5 x I_n

Time/current characteristic

- definite time characteristic
 - operate time t> 0.05...300 s
- inverse definite minimum time (IDMT) characteristic as per IEC 60255-3 and BS 142
 - Extremely inverse
 - Very inverse
 - Normal inverse
 - Long-time inverse
 - RI-type inverse
 - RXIDG-type inverse
- special type inverse characteristic
 - time multiplier k 0.05...1.0

High-set overcurrent stage I>> *

Start current

0.5...40 x I_n and ∞, infinite

Operate time t>>

0.04...300 s

Earth-fault unit of SPCJ 4D29

Low-set earth-fault stage I₀> *

Start current

0.1...0.8 x I_n

Time/current characteristic

- definite time characteristic
 - operate time t₀> 0.05...300 s
- inverse definite minimum time (IDMT) characteristic as per IEC 60255-3 and BS 142
 - Extremely inverse
 - Very inverse
 - Normal inverse
 - Long-time inverse
 - RI-type inverse
 - RXIDG-type inverse

- special type inverse characteristic
 - time multiplier k₀ 0.05...1.0

High-set earth-fault stage I₀>> *

Start current

0.1...10.0 x I_n and ∞, infinite

Operate time t₀>>

0.05... 300 s

* Note!

The operation of the low-set stage based on inverse time characteristic will be blocked¹⁾ by starting of the high-set stage. Then the operate time of the low-set stage is determined by the set operate time of the high-set stage at heavy fault currents. In order to obtain a trip signal, the high-set stage must be routed to a trip output relay.

¹⁾ From program version 183 B and later this function can be switched off with switch 2 of the extended switchgroup, SGX. By default this function is switched off.

** Note!

If the set start current exceeds 2.5 x I_n, the maximum continuous carry of the energizing inputs (4 x I_n) must be noted.

*** Note!

Because of the maximum measured current (63 x I_n), the setting value 2.5 is used for the IDMT calculation if the set value is greater than 2.5. This makes the operate time faster than the theoretical IDMT curve. However, the stage always starts according to the set value.

Data transmission

Transmission mode	Fibre optic serial bus
Data code	ASCII
Selectable data transfer rates	4800 or 9600 Bd
Fibre optic bus connection modules for powering from external power source	
- for plastic core cables	SPA-ZC 17 BB
- for glass fibre cables	SPA-ZC 17 MM
Fibre optic bus connection modules for powering from host relay	
- for plastic core cables	SPA-ZC 21 BB
- for glass fibre cables	SPA-ZC 21 MM

Insulation Tests *)

Dielectric test IEC 60255-5	2 kV, 50 Hz, 1 min
Impulse voltage test IEC 60255-5	5 kV, 1.2/50 μ s, 0.5 J
Insulation resistance measurement IEC 60255-5	>100 M Ω , 500 Vdc

Electromagnetic Compatibility Tests *)

High-frequency (1 MHz) burst disturbance test IEC 60255-22-1	
- common mode	2.5 kV
- differential mode	1.0 kV
Electrostatic discharge test IEC 60255-22-2 and IEC 61000-4-2	
- contact discharge	6 kV
- air discharge	8 kV
Fast transient disturbance test IEC 60255-22-4 and IEC 61000-4-4	
- power supply	4 kV
- I/O ports	2 kV
Spike test, class III (KEMA)	1 kV, 0.15/50 μ s
Magnetic field test acc. to IEC 60521	400 A/m

Power supply tests

Power supply variation	
Variation voltage	68...265 V
Interruption 80 V - 50%	0...200 ms
Interruption 80 V - 100%	0...30 ms
Interruption 255 V - 100%	0...160 ms

Mechanical tests

Vibration tests	IEC 60255-21-1, class 2
Shock and Bump tests	IEC 60255-21-2, class 2
Seismic tests	ANS/IEEE C37.98-1987 - 3.0 g in the horizontal direction - 3.0 g in the vertical direction

Environmental conditions

Corrosion test	Battelle-test
Specified ambient service temperature range	-10...+55°C
Long term damp heat withstand according to IEC 60068-2-3	<95% at 40°C for 56 d
Transport and storage temperature range	-40...+70°C
Protection by enclosure according to IEC 60529, when the relay is panel mounted	IP 54
Mass of the relay including flush mounting relay case	~3.5 kg

*) The tests do not apply to the serial port, which is used exclusively for the bus connection module.

Maintenance and repair

When the protection relay is operating under the conditions specified in the section "Technical data", the relay is practically maintenance-free. The relay modules include no parts or components subject to an abnormal physical or electrical wear under normal operating conditions.

If the environmental conditions at the relay operating site differ from those specified, as to temperature, humidity, or if the atmosphere around the relay contains chemically active gases or dust, the relay ought to be visually inspected in association with the relay secondary test or whenever the relay modules are withdrawn from the case. At the visual inspection the following things should be noted:

- Signs of mechanical damage on relay modules, contacts and relay case
- Accumulation of dust inside the relay cover or case; remove by blowing air carefully
- Rust spots or signs of erugo on terminals, case or inside the relay

On request, the relay can be given a special treatment for the protection of the printed circuit boards against stress on materials, caused by abnormal environmental conditions.

If the relay fails in operation or if the operating values remarkably differ from those of the relay specifications, the relay should be given a proper overhaul. Minor measures can be taken by personnel from the instrument work-shop of the customer's company, e.g. replacement of auxiliary relay modules. All major measures involving overhaul of the electronics are to be taken by the manufacturer. Please contact the manufacturer or his nearest representative for further information about checking, overhaul and recalibration of the relay.

Note!

Numerical protection relays contain electronic circuits which are liable to serious damage due to electrostatic discharge. Before removing a module containing electronic circuits, ensure that you are at the same electrostatic potential as the equipment, for instance, by touching the relay case.

Note!

Static protection relays are measuring instruments and should be handled with care and protected against moisture and mechanical stress, especially during transport.

Spare parts

Three-phase overcurrent and earth-fault module
Power supply and output relay module
 $U_{aux} = 80...265 \text{ V ac/dc}$
 $U_{aux} = 18...80 \text{ V dc}$
Input module
Bus connection module

SPCJ 4D29

SPTU 240 R1

SPTU 48 R1

SPTE 4E1

SPA-ZC 17__ or SPA-ZC 21__

Dimensions for mounting

The relay is housed in a normally flush-mounted case. The relay can also be arranged for semi-flush mounting with the use of a 40 mm, 80 mm or 120 mm raising frame, which reduces the depth behind the panel by the same dimension. The type designations of the raising frames are SPA-ZX 111 for the 40 mm frame, SPA-ZX 112 for the 80 mm frame and SPA-ZX 113 for the 120 mm frame. A surface mounting case SPA-ZX 110 is also available.

The relay case is made of profile aluminium and finished in beige.

A cast aluminium alloy mounting frame with a rubber gasket provides a degree of protection by enclosure to IP 54 between the relay case and the

panel surface when the relay is panel mounted. The relay case is complete with a hinged gasketed, clear, UV-stabilized polycarbonate cover with a sealable fastening screw. The degree of protection by enclosure of the cover is also IP 54.

A terminal strip and two multipole connectors are mounted on the back of the relay case to facilitate all input and output connections. To each heavy duty terminal, i.e. measuring input, power supply or trip output, one 6 mm², one 4 mm² or one or two 2.5 mm² wires can be connected. No terminal lugs are needed. The signalling outputs are available on a six pole detachable connector and the serial bus connection is using a 9-pin D-type connector.

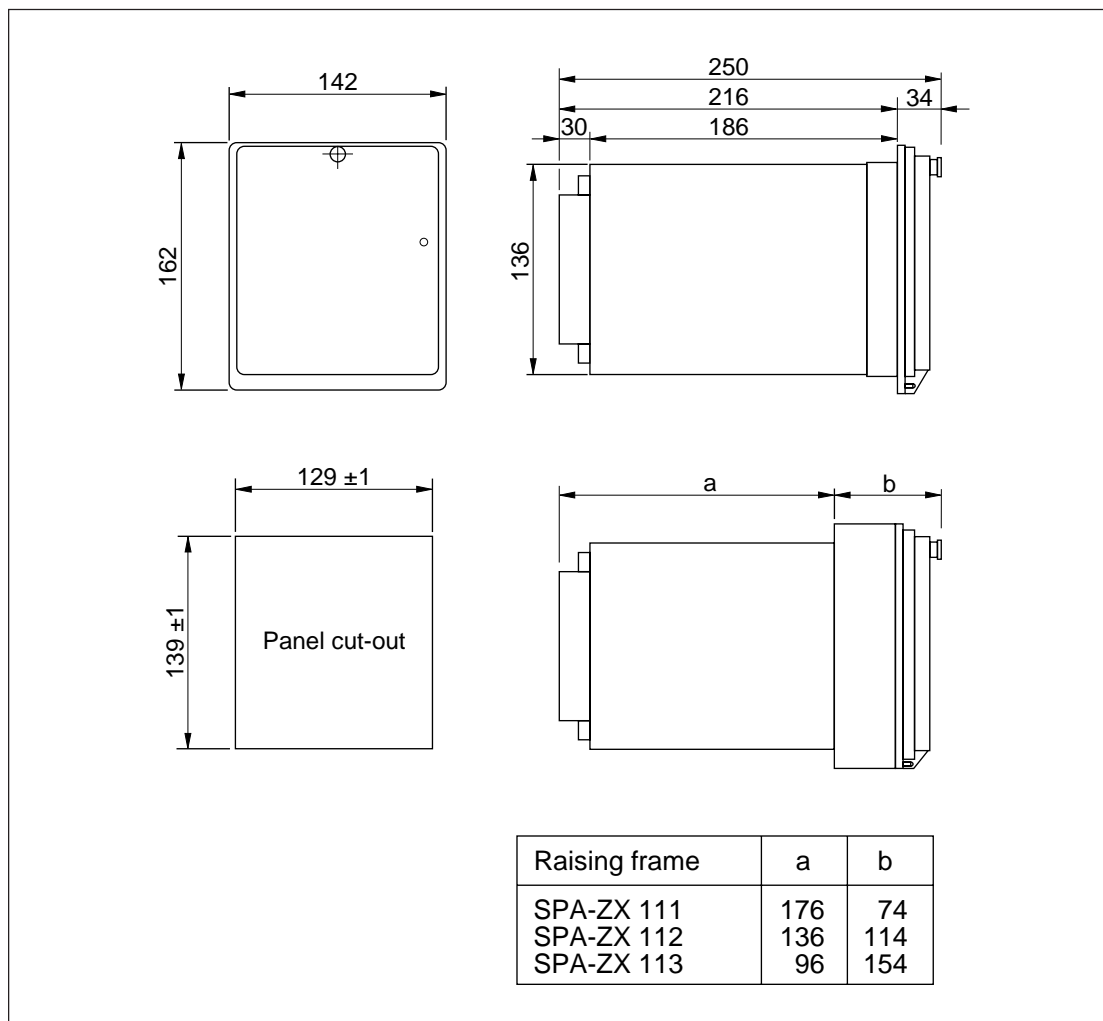

Order information

1. Quantity and type designation
2. Rated frequency
3. Auxiliary voltage
4. Accessories
5. Special requirements

Example

15 pcs relay type SPAJ 140 C
 $f_n = 50$ Hz
 $U_{aux} = 110$ V dc
 15 pcs bus connection modules SPA-ZC17 MM
 2 pcs fibre optical cables SPA-ZF MM 100
 14 pcs fibre optical cables SPA-ZF MM 5

General characteristics of D-type relay modules

User's manual and Technical description

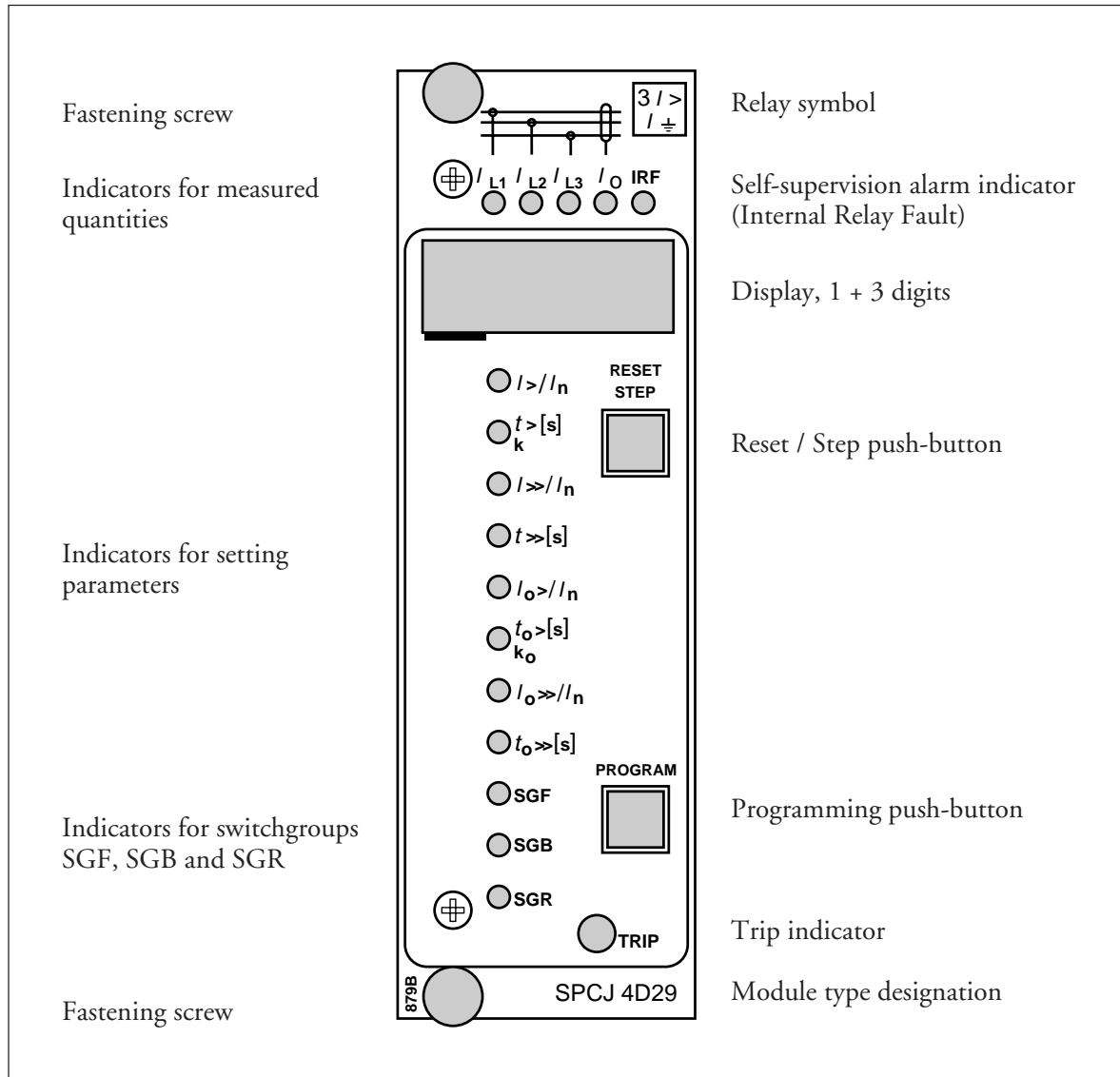

General characteristics of D type relay modules

Data subject to change without notice

Contents

Front panel lay-out	1
Control push buttons	3
Display	3
Display main menu	3
Display submenus	3
Selector switchgroups SGF, SGB, SGR	4
Settings	4
Setting mode	4
Example 1: Setting of relay operation values	7
Example 2: Setting of relay switchgroups	9
Recorded information	11
Trip test function	12
Example 3: Forced activation of outputs	13
Operation indicators	15
Fault codes	15

Control push-buttons	<p>The front panel of the relay module contains two push buttons. The RESET / STEP push button is used for resetting operation indicators and for stepping forward or backward in the display main menu or submenus. The PROGRAM push button is used for moving from a</p>	<p>certain position in the main menu to the corresponding submenu, for entering the setting mode of a certain parameter and together with the STEP push button for storing the set values. The different operations are described in the subsequent paragraphs in this manual.</p>
Display	<p>The measured and set values and the recorded data are shown on the display of the protection relay module. The display consists of four digits. The three green digits to the right show the measured, set or recorded value and the leftmost red digit shows the code number of the register. The measured or set value displayed is indicated by the adjacent yellow LED indicator on the front panel. When a recorded fault value is being displayed the red digit shows the number of the corresponding register. When the display functions as an operation indicator the red digit alone is shown.</p>	<p>When the auxiliary voltage of a protection relay module is switched on the module initially tests the display by stepping through all the segments of the display for about 15 seconds. At first the corresponding segments of all digits are lit one by one clockwise, including the decimal points. Then the center segment of each digit is lit one by one. The complete sequence is carried out twice. When the test is finished the display turns dark. The testing can be interrupted by pressing the STEP push button. The protection functions of the relay module are alerted throughout the testing.</p>
Display main menu	<p>Any data required during normal operation are accessible in the main menu i.e. present measured values, present setting values and recorded parameter values.</p> <p>The data to be shown in the main menu are sequentially called up for display by means of the STEP push button. When the STEP push button is pressed for about one second, the display moves forward in the display sequence. When the push button is pressed for about 0.5 seconds, the display moves backward in the display sequence.</p>	<p>From a dark display only forward movement is possible. When the STEP push button is pushed constantly, the display continuously moves forward stopping for a while in the dark position.</p> <p>Unless the display is switched off by stepping to the dark point, it remains lit for about 5 minutes from the moment the STEP push button was last pushed. After the 5 minutes' time-out the display is switched off.</p>
Display submenus	<p>Less important values and values not very often set are displayed in the submenus. The number of submenus varies with different relay module types. The submenus are presented in the description of the concerned protection relay module.</p> <p>A submenu is entered from the main menu by pressing the PROGRAM push button for about one second. When the push button is released, the red digit of the display starts flashing, indicating that a submenu has been entered. Going from one submenu to another or back to the main menu follows the same principle as when moving from the main menu display to another;</p>	<p>the display moves forward when the STEP push button is pushed for one second and backward when it is pushed for 0.5 seconds. The main menu has been re-entered when the red display turns dark.</p> <p>When a submenu is entered from a main menu of a measured or set value indicated by a LED indicator, the indicator remains lit and the address window of the display starts flashing. A submenu position is indicated by a flashing red address number alone on the display without any lit set value LED indicator on the front panel.</p>

Selector switch-groups SGF, SGB and SGR

Part of the settings and the selections of the operation characteristic of the relay modules in various applications are made with the selector switchgroups SG_. The switchgroups are software based and thus not physically to be found in the hardware of the relay module. The indicator of the switchgroup is lit when the checksum of the switchgroup is shown on the display. Starting from the displayed checksum and by entering the setting mode, the switches can be set one by one as if they were real physical switches. At the end of the setting procedure, a checksum for the whole switchgroup is shown. The checksum can be used for verifying that the switches have been properly set. Fig. 2 shows an example of a manual checksum calculation.

When the checksum calculated according to the example equals the checksum indicated on the display of the relay module, the switches in the concerned switchgroup are properly set.

Switch No	Pos.		Weight	Value
1	1	x	1	= 1
2	0	x	2	= 0
3	1	x	4	= 4
4	1	x	8	= 8
5	1	x	16	= 16
6	0	x	32	= 0
7	1	x	64	= 64
8	0	x	128	= 0
Checksum			Σ	= 93

Fig. 2. Example of calculating the checksum of a selector switchgroup SG_.

The functions of the selector switches of the different protection relay modules are described in detail in the manuals of the different relay modules.

Settings

Most of the start values and operate times are set by means of the display and the push buttons on the front panel of the relay modules. Each setting has its related indicator which is lit when the concerned setting value is shown on the display.

In addition to the main stack of setting values most D type relay modules allow a second stack of settings. Switching between the main settings

and the second settings can be done in three different ways:

- 1) By command V150 over the serial communication bus
- 2) By an external control signal BS1, BS2 or RRES (BS3)
- 3) Via the push-buttons of the relay module, see submenu 4 of register A.

Setting mode

Generally, when a large number of settings is to be altered, e.g. during commissioning of relay systems, it is recommended that the relay settings are entered with the keyboard of a personal computer provided with the necessary software. When no computer nor software is available or when only a few setting values need to be altered the procedure described below is used.

The registers of the main menu and the submenus contain all parameters that can be set. The settings are made in the so called setting mode, which is accessible from the main menu or a submenu by pressing the PROGRAM push button, until the whole display starts flashing. This position indicates the value of the parameter before it has been altered. By pressing the PROGRAM push button the programming sequence moves forward one step. First the rightmost digit starts flashing while the rest of the display is steady. The flashing digit is set by means of the STEP push button. The flashing

cursor is moved on from digit to digit by pressing the PROGRAM push button and in each stop the setting is performed with the STEP push button. After the parameter values have been set, the decimal point is put in place. At the end the position with the whole display flashing is reached again and the data is ready to be stored.

A set value is recorded in the memory by pressing the push buttons STEP and PROGRAM simultaneously. Until the new value has been recorded a return from the setting mode will have no effect on the setting and the former value will still be valid. Furthermore *any attempt to make a setting outside the permitted limits for a particular parameter will cause the new value to be disqualified and the former value will be maintained.* Return from the setting mode to the main menu or a submenu is possible by pressing the PROGRAM push button until the green digits on the display stop flashing.

NOTE! During any local man-machine communication over the push buttons and the display on the front panel a five minute time-out function is active. Thus, if no push button has been pressed during the last five minutes, the relay returns to its normal state automatically. This means that the display turns dark, the relay escapes from a display mode, a programming routine or any routine going on, when the relay is left untouched. This is a convenient way out of any situation when the user does not know what to do.

Before a relay module is inserted into the relay case, one must assure that the module has been given the correct settings. If there however is

any doubt about the settings of the module to be inserted, the setting values should be read using a spare relay unit or with the relay trip circuits disconnected. If this cannot be done the relay can be set into a non-tripping mode by pressing the PROGRAM push button and powering up the relay module simultaneously. The display will show three dashes "---" to indicate the non-tripping mode. The serial communication is operative and all main and submenus are accessible. In the non-tripping mode unnecessary trippings are avoided and the settings can be checked. *The normal protection relay mode is entered automatically after a timeout of five minutes or ten seconds after the dark display position of the main menu has been entered.*

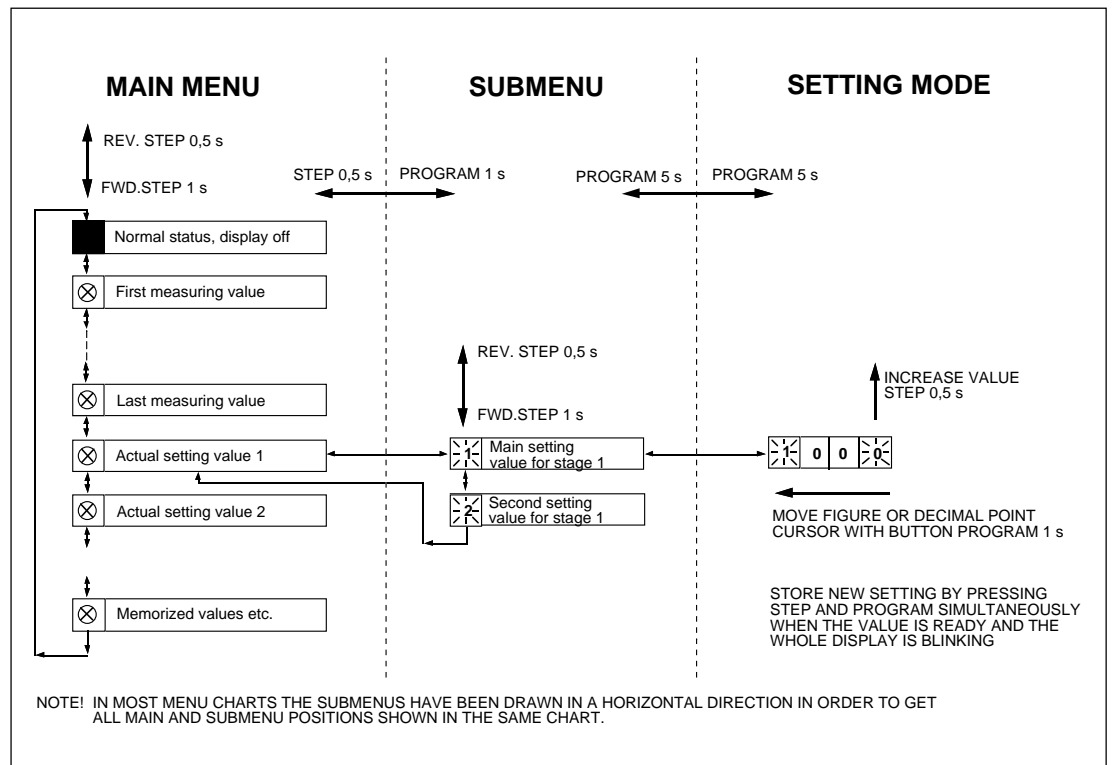

Fig.3. Basic principles of entering the main menus and submenus of a relay module.

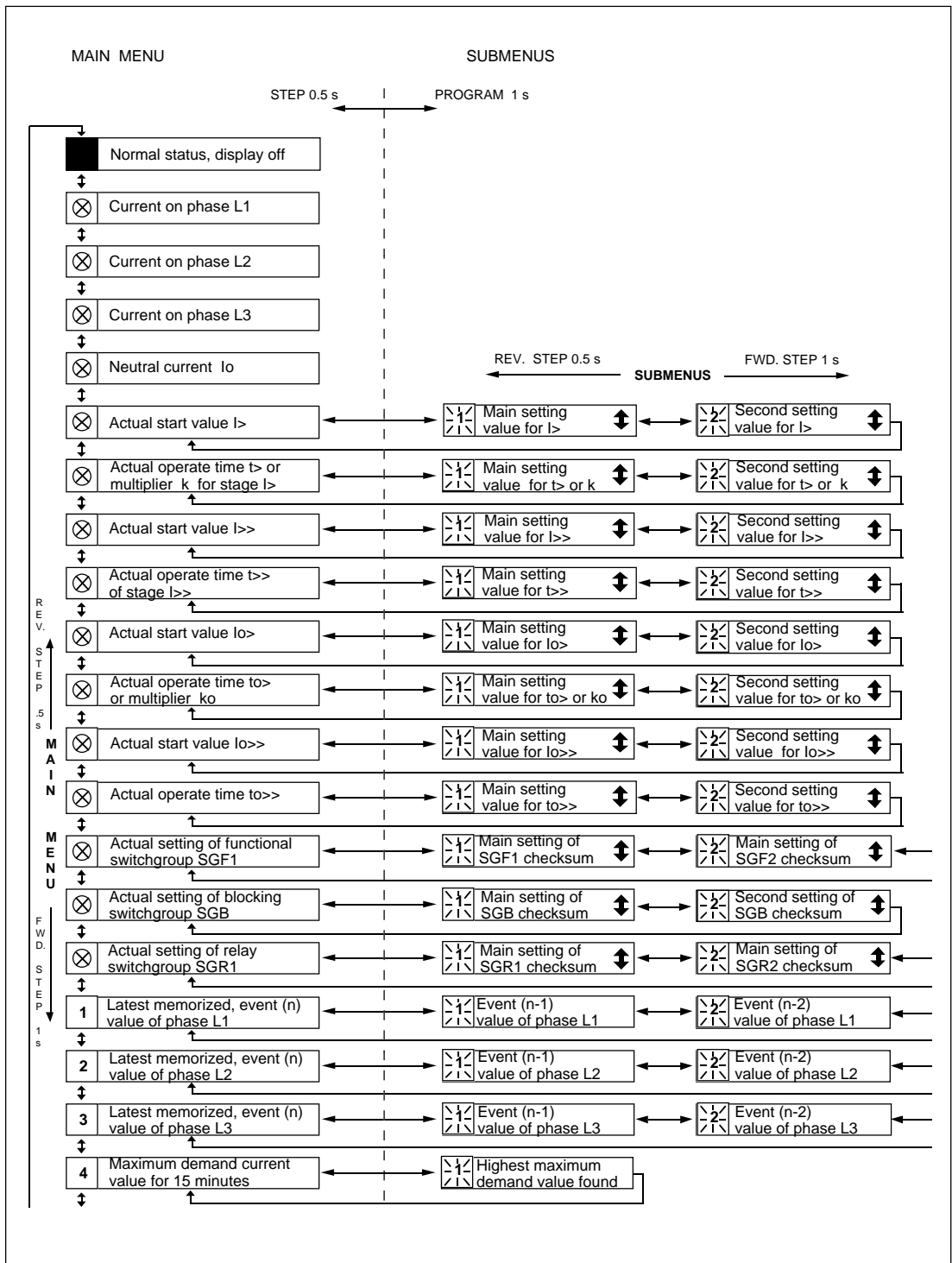

Fig. 4. Example of part of the main and submenus for the settings of the overcurrent and earth-fault relay module SPCJ 4D29. The settings currently in use are in the main menu and they are displayed by pressing the STEP push button. The main menu also includes the measured current values, the registers 1...9, 0 and A. The main and second setting values are located in the submenus and are called up on the display with the PROGRAM push button.

Example 1

Operation in the setting mode. Manual setting of the main setting of the start current value $I>$ of an overcurrent relay module. The initial value

for the main setting is $0.80 \times I_n$ and for the second setting $1.00 \times I_n$. The desired main start value is $1.05 \times I_n$.

a) Press push button STEP repeatedly until the LED close to the $I>$ symbol is lit and the current start value appears on the display.

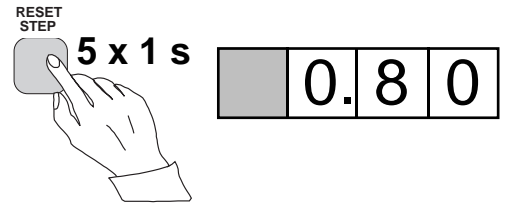

b) Enter the submenu to get the main setting value by pressing the PROGRAM push button more than one second and then releasing it. The red display digit now shows a flashing number 1, indicating the first submenu position and the green digits show the set value.

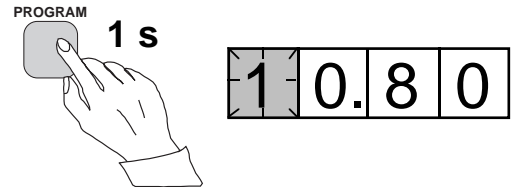

c) Enter the setting mode by pressing the PROGRAM push button for five seconds until the display starts flashing.

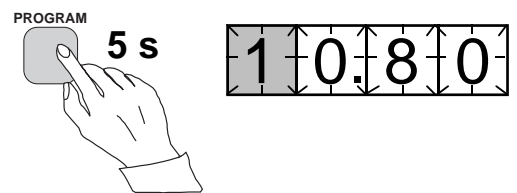

d) Press the PROGRAM push button once again for one second to get the rightmost digit flashing.

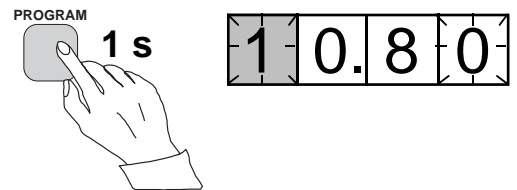

e) Now the flashing digit can be altered. Use the STEP push button to set the digit to the desired value.

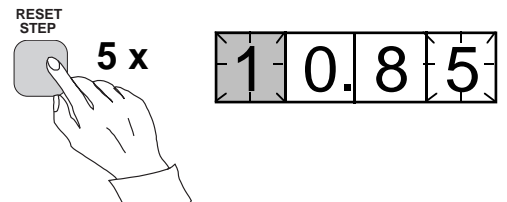

f) Press the PROGRAM push button to make the middle one of the green digits flash.

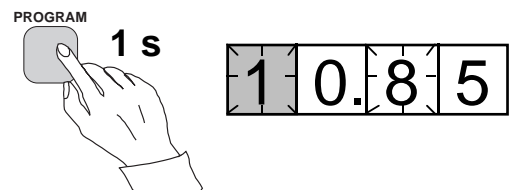

g) Set the middle digit with of the STEP push button.

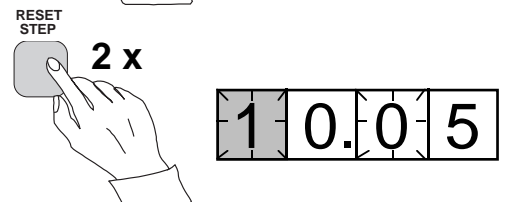

h) Press the PROGRAM push button to make the leftmost green digit flash.

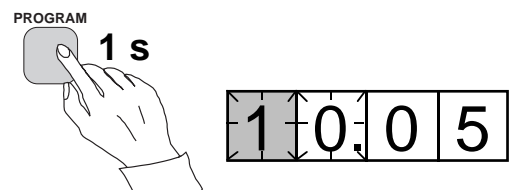

i) Set the digit with the STEP push button.

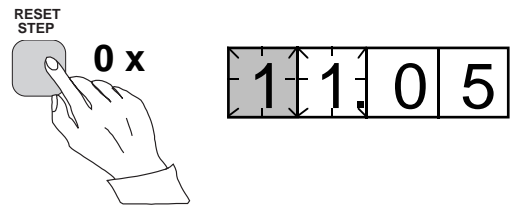

j) Press the PROGRAM push button to make the decimal point flash.

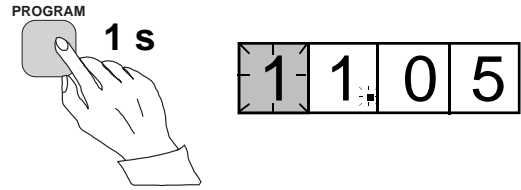

k) If needed, move the decimal point with the STEP push button.

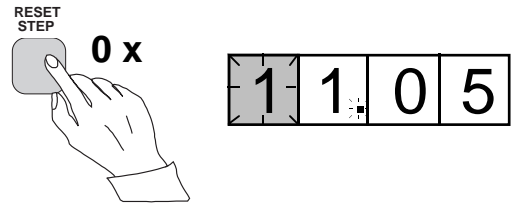

l) Press the PROGRAM push button to make the whole display flash. In this position, corresponding to position c) above, one can see the new value before it is recorded. If the value needs changing, use the PROGRAM push button to alter the value.

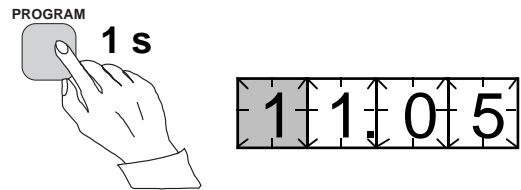

m) When the new value has been corrected, record it in the memory of the relay module by pressing the PROGRAM and STEP push buttons simultaneously. At the moment the information enters the memory, the green dashes flash once in the display, i.e. 1 - - -.

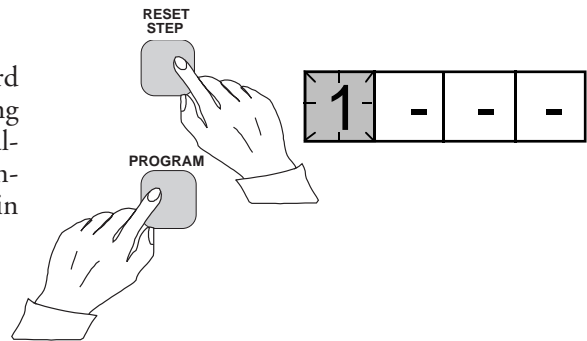

n) Recording of the new value automatically initiates a return from the setting mode to the normal submenu. Without recording one can leave the setting mode any time by pressing the PROGRAM push button for about five seconds, until the green display digits stop flashing.

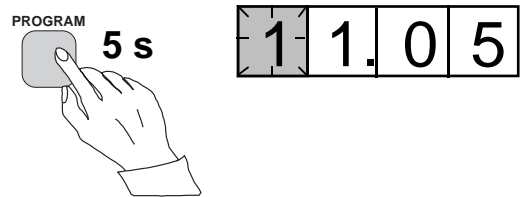

o) If the second setting is to be altered, enter submenu position 2 of the setting I> by pressing the STEP push button for approx. one second. The flashing position indicator 1 will then be replaced by a flashing number 2 which indicates that the setting shown on the display is the second setting for I>.

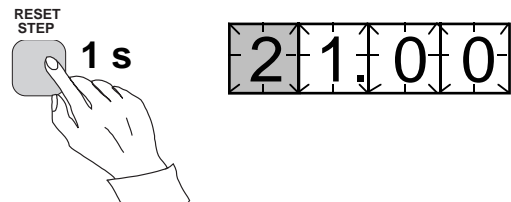

Enter the setting mode as in step c) and proceed in the same way. After recording of the requested values return to the main menu is obtained by pressing the STEP push button

until the first digit is switched off. The LED still shows that one is in the I> position and the display shows the new setting value currently in use by the relay module.

Example 2

Operation in the setting mode. Manual setting of the main setting of the checksum for the switchgroup SGF1 of a relay module. The initial value for the checksum is 000 and the switches

SGF1/1 and SGF1/3 are to be set in position 1. This means that a checksum of 005 should be the final result.

a) Press push button STEP until the LED close to the SGF symbol is lit and the checksum appears on the display.

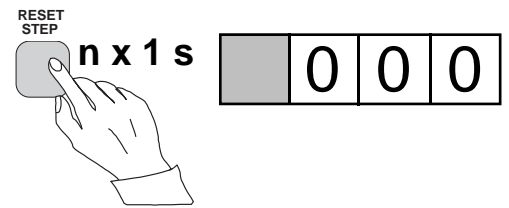

b) Enter the submenu to get the main checksum of SGF1 by pressing the PROGRAM push button for more than one second and then releasing it. The red display now shows a flashing number 1 indicating the first submenu position and the green digits show the checksum.

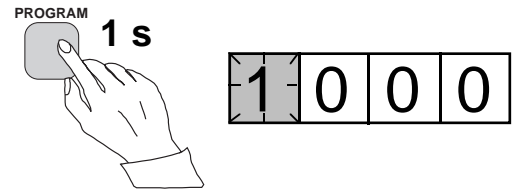

c) Enter the setting mode by pressing the PROGRAM push button for five seconds until the display starts flashing.

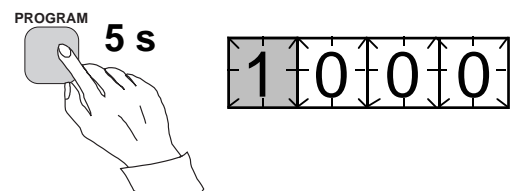

d) Press the PROGRAM push button once again to get the first switch position. The first digit of the display now shows the switch number. The position of the switch is shown by the rightmost digit.

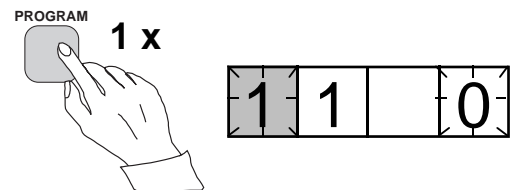

e) The switch position can now be toggled between 1 and 0 by means of the STEP push button and it is left in the requested position 1.

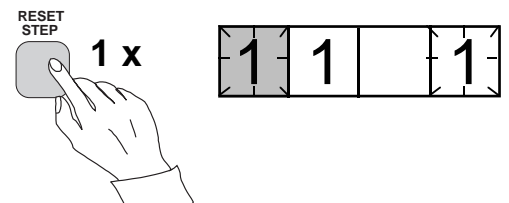

f) When switch number 1 is in the requested position, switch number 2 is called up by pressing the PROGRAM push button for one second. As in step e), the switch position can be altered by using the STEP push button. As the desired setting for SGF1/2 is 0 the switch is left in the 0 position.

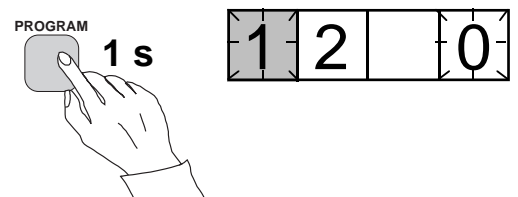

g) Switch SGF1/3 is called up as in step f) by pressing the PROGRAM push button for about one second.

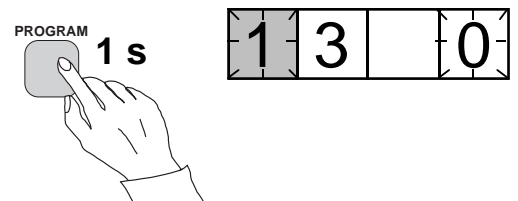

h)
The switch position is altered to the desired position 1 by pressing the STEP push button once.

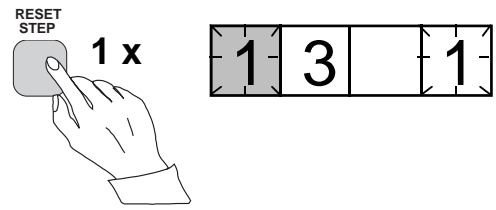

i)
Using the same procedure the switches SGF 1/4...8 are called up and, according to the example, left in position 0.

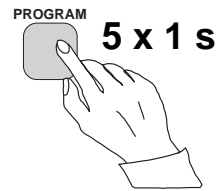

j)
In the final setting mode position, corresponding to step c), the checksum based on the set switch positions is shown.

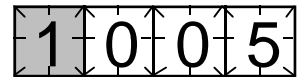

k)
If the correct checksum has been obtained, it is recorded in the memory by pressing the push buttons PROGRAM and STEP simultaneously. At the moment the information enters the memory, the green dashes flash in the display, i.e. 1 - - -. If the checksum is incorrect, the setting of the separate switches is repeated using the PROGRAM and STEP push buttons starting from step d).

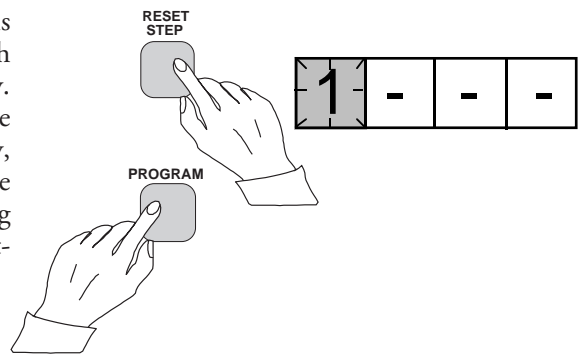

l)
Recording the new value automatically initiates a return from the setting mode to the normal menu. Without recording one can leave the setting mode any time by pressing the PROGRAM push button for about five seconds, until the green display digits stop flashing.

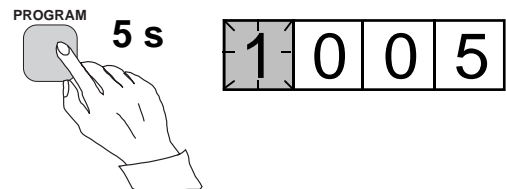

m)
After recording the desired values return to the main menu is obtained by pressing the STEP push button until the first digit is turned off. The LED indicator SGF still shows that one is in the SGF position and that the display shows the new checksum for SGF1 currently in use by the relay module.

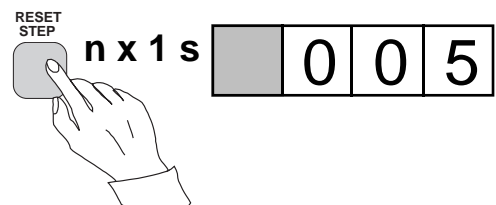

Recorded information

The parameter values measured at the moment when a fault occurs or at the trip instant are recorded in the registers. The recorded data, except for some parameters, are set to zero by pressing the push buttons STEP and PROGRAM simultaneously. The data in normal registers are erased if the auxiliary voltage supply to the relay is interrupted, only the set values and certain other essential parameters are maintained in non-volatile registers during a voltage failure.

The number of registers varies with different relay module types. The functions of the registers are illustrated in the descriptions of the different relay modules. Additionally, the system front panel of the relay contains a simplified list of the data recorded by the various relay modules of the protection relay.

All D type relay modules are provided with two general registers: register 0 and register A.

Register 0 contains, in coded form, the information about e.g. external blocking signals, status information and other signals. The codes are explained in the manuals of the different relay modules.

Register A contains the address code of the relay modul which is required by the serial communication system.

Submenu 1 of register A contains the data transfer rate value, expressed in kilobaud, of the serial communication.

Submenu 2 of register A contains a bus communication monitor for the SPAbus. If the protection relay, which contains the relay module, is linked to a system including a control data communicatoe, for instance SRIO 1000M and the data communication system is operating, the counter reading of the monitor will be zero. Otherwise the digits 1...255 are continuously scrolling in the monitor.

Submenu 3 contains the password required for changing the remote settings. The address code, the data transfer rate of the serial communication and the password can be set manually or via the serial communication bus. For manual setting see example 1.

The default value is 001 for the address code, 9.6 kilobaud for the data transfer rate and 001 for the password.

In order to secure the setting values, all settings are recorded in two separate memory banks within the non-volatile memory. Each bank is complete with its own checksum test to verify the condition of the memory contents. If, for some reason, the contents of one bank is disturbed, all settings are taken from the other bank and the contents from here is transferred to the faulty memory region, all while the relay is in full operation condition. If both memory banks are simultaneously damaged the relay will be set out of operation, and an alarm signal will be given over the serial port and the IRF output relay

Trip test function

Register 0 also provides access to a trip test function, which allows the output signals of the relay module to be activated one by one. If the auxiliary relay module of the protection assembly is in place, the auxiliary relays then will operate one by one during the testing.

When pressing the PROGRAM push button for about five seconds, the green digits to the right start flashing indicating that the relay module is in the test position. The indicators of the settings indicate by flashing which output signal can be activated. The required output function is selected by pressing the PROGRAM push button for about one second.

The indicators of the setting quantities refer to the following output signals:

Setting I>	Starting of stage I>
Setting t>	Tripping of stage I>
Setting I>>	Starting of stage I>>
Setting t>>	Tripping of stage I>>
etc.	
No indication	Self-supervision IRF

The selected starting or tripping is activated by simultaneous pressing of the push buttons STEP and PROGRAM. The signal remains activated as long as the two push buttons are pressed. The effect on the output relays depends on the configuration of the output relay matrix switches.

The self-supervision output is activated by pressing the STEP push button 1 second when no setting indicator is flashing. The IRF output is activated in about 1 second after pressing of the STEP push button.

The signals are selected in the order illustrated in Fig. 4.

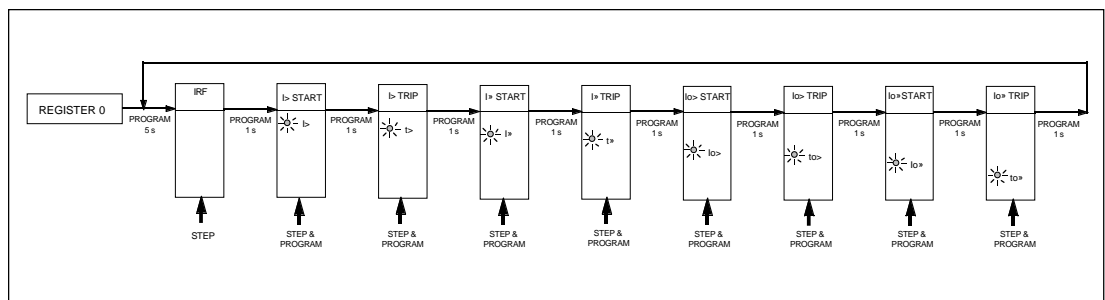

Fig. 5. Sequence order for the selection of output signals in the Trip test mode

If, for instance, the indicator of the setting t> is flashing, and the push buttons STEP and PROGRAM are being pressed, the trip signal from the low-set overcurrent stage is activated. Return to the main menu is possible at any stage of the trip test sequence scheme, by pressing the PROGRAM push button for about five seconds.

Note!
The effect on the output relays then depends on the configuration of the output relay matrix switchgroups SGR 1...3.

Example 3

Trip test function. Forced activation of the outputs.

- a)
Step forward on the display to register 0.

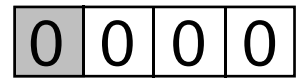
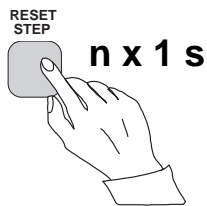

- b)
Press the PROGRAM push button for about five seconds until the three green digits to the right.

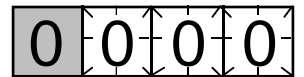
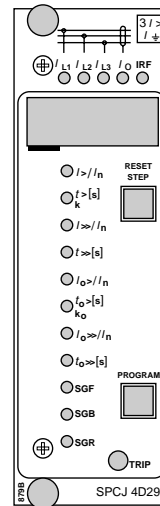

- c)
Hold down the STEP push button. After one second the red IRF indicator is lit and the IRF output is activated. When the step push button is released the IRF indicator is switched off and the IRF output resets.

- d)
Press the PROGRAM push button for one second and the indicator of the topmost setting start flashing.

- e)
If a start of the first stage is required, now press the push-buttons PROGRAM and STEP simultaneously. The stage output will be activated and the output relays will operate according to the actual programming of the relay output switchgroups SGR.

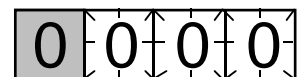
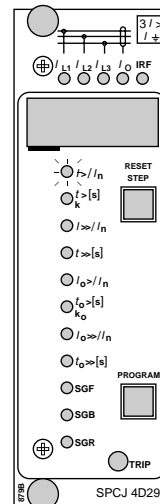
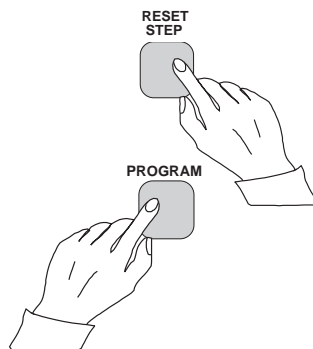

f)
To proceed to the next position press the PROGRAM push button for about 1 second until the indicator of the second setting starts flashing.

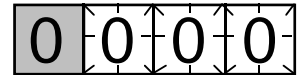
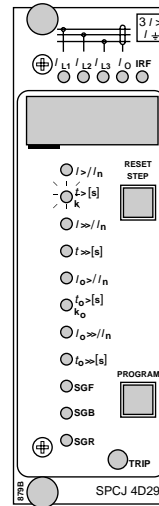

g)
Press the push buttons PROGRAM and STEP simultaneously to activate tripping of stage 1 (e.g. the I> stage of the overcurrent module SPCJ 4D29). The output relays will operate according to the actual programming of the relay switchgroups SGR. If the main trip relay is operated the trip indicator of the measuring module is lit.

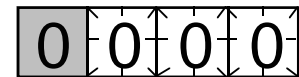
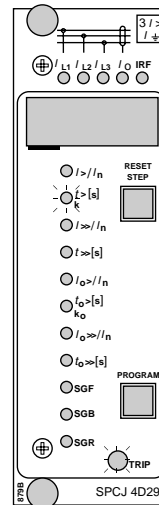
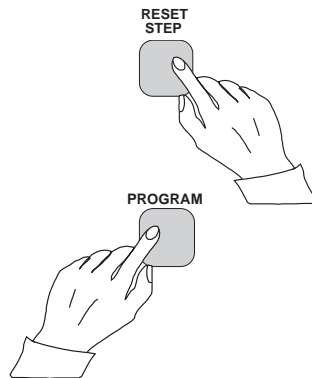

h)
The starting and tripping of the remaining stages are activated in the same way as the first stage above. The indicator of the corresponding setting starts flashing to indicate that the concerned stage can be activated by pressing the STEP and PROGRAM buttons simultaneously. For any forced stage operation, the output relays will respond according to the setting of the relay output switchgroups SGR. Any time a certain stage is selected that is not wanted to operate, pressing the PROGRAM button once more will pass by this position and move to the next one without carrying out any operation of the selected stage.

It is possible to leave the trip test mode at any step of the sequence scheme by pressing the PROGRAM push button for about five seconds until the three digits to the right stop flashing.

Operation indication

A relay module is provided with a multiple of separate operation stages, each with its own operation indicator shown on the display and a common trip indicator on the lower part of the front plate of the relay module.

The starting of a relay stage is indicated with one number which changes to another number when the stage operates. The indicator remains glowing although the operation stage resets. The

indicator is reset by means of the RESET push button of the relay module. An unreset operation indicator does not affect the function of the protection relay module.

In certain cases the function of the operation indicators may deviate from the above principles. This is described in detail in the descriptions of the separate modules.

Fault codes

In addition to the protection functions the relay module is provided with a self-supervision system which continuously supervises the function of the microprocessor, its program execution and the electronics.

Shortly after the self-supervision system detects a permanent fault in the relay module, the red IRF indicator on the front panel is lit. At the same time the module puts forward a control signal to the output relay of the self-supervision system of the protection relay.

In most fault situations a fault code, indicating the nature of the fault, appears on the display of

the module. The fault code, which consists of a red figure "1" and a three digit green code number, cannot be removed from the display by resetting. When a fault occurs, the fault code should be recorded and stated when service is ordered. When in a fault mode, the normal relay menus are operative, i.e. all setting values and measured values can be accessed although the relay operation is inhibited. The serial communication is also operative making it possible to access the relay information also from a remote site. The internal relay fault code shown on the display remains active until the internal fault possibly disappears and can also be remotely read out as variable V 169.

SPCJ 4D29

Overcurrent and earth-fault relay module

User's manual and Technical description

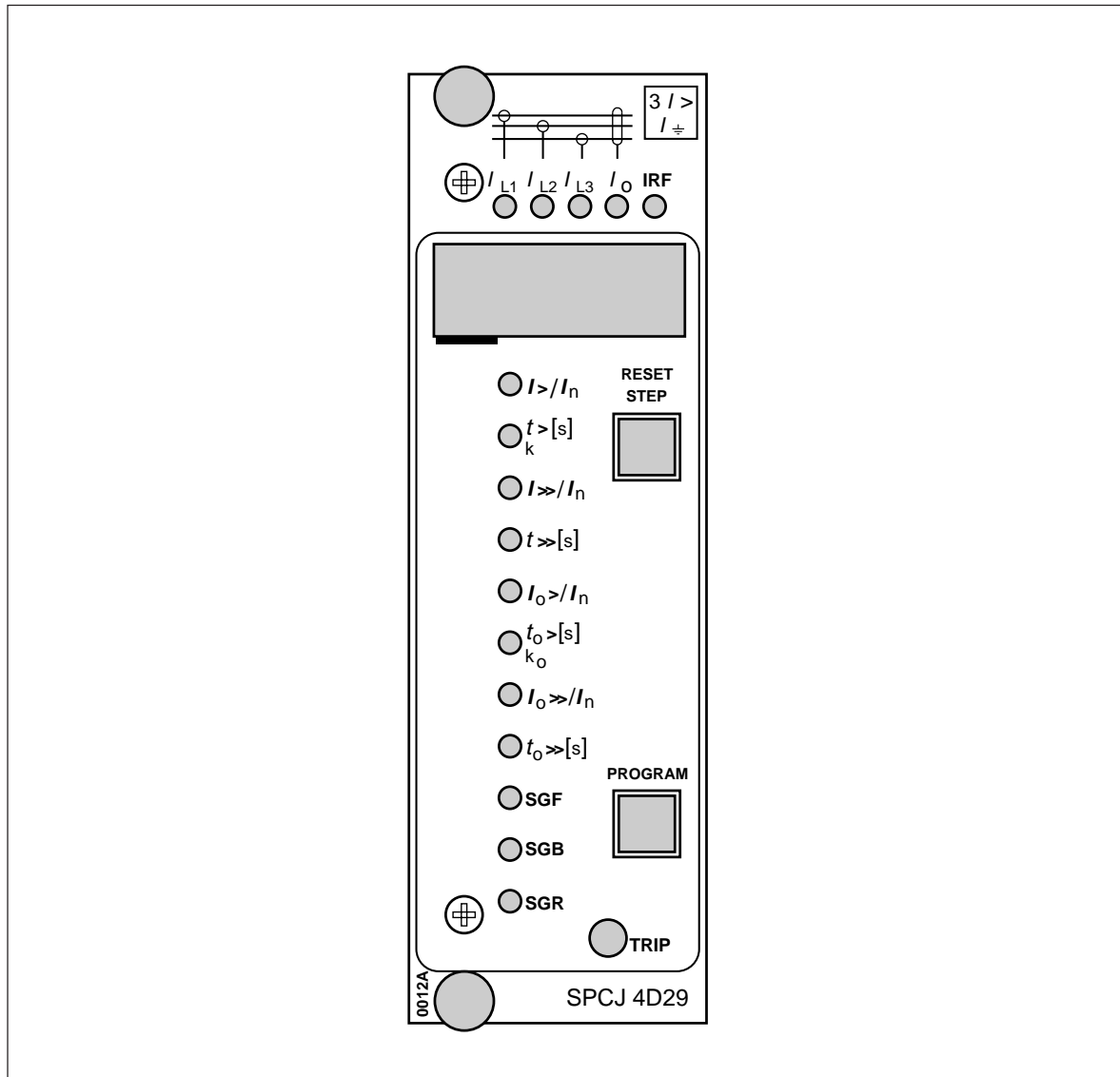

SPCJ 4D29

Combined overcurrent and earth-fault relay module

Data subject to change without notice

Contents	Features	2
	Description of function (<i>modified 2007-03</i>)	3
	Block diagram	5
	Front panel	6
	Start and operation indicators	7
	Settings (<i>modified 2007-03</i>)	8
	Selector switches (<i>modified 2007-03</i>)	9
	Measured data	13
	Recorded information (<i>modified 2007-03</i>)	14
	Menu and register chart (<i>modified 2007-03</i>)	16
	Time/current characteristic (<i>modified 2007-03</i>)	18
	Technical data (<i>modified 2007-03</i>)	26
	Serial communication parameters (<i>modified 2007-03</i>)	27
	Fault codes	34

Features	Low-set phase overcurrent stage $I_{>}$ with definite time or inverse time characteristic	Six time/current curve sets at inverse time characteristic of the overcurrent stage $I_{>}$ and the earth-fault stage $I_{0>}$
	High-set phase overcurrent stage $I_{>>}$ with instantaneous function or definite time characteristic	Digital display of measured and set values and data sets recorded at the moment of relay operation
	Low-set earth-fault stage $I_{0>}$ with definite time or inverse time characteristic	Parametrization of the module by push-buttons on the front panel or via the serial port using a portable PC and a suitable software
	High-set earth-fault stage $I_{0>>}$ with definite time characteristic	Continuous hardware and software supervision including auto-diagnosis

Description of function
(modified 2007-03)

Phase overcurrent unit

The phase overcurrent unit of the relay module SPCJ 4D29 is designed for single-phase, two-phase or three-phase overcurrent protection. It includes two overcurrent stages, i.e. a low-set overcurrent stage I_> and a high-set overcurrent stage I_{>>}.

The low-set or high-set phase overcurrent stage starts if the current on one or several of the phases exceeds the set start current value of the stage concerned. When the stage starts it generates a start signal SS1 or TS1 and simultaneously the digital display on the front panel indicates starting. If the overcurrent situation lasts long enough to exceed the set operate time, the stage operates and generates a trip signal TS2. At the same time the operation indicator is lit with red light. The red operation indicator remains lit although the stage resets. The indicator is reset by pushing the RESET push-button. By proper configuration of the output relay switchgroups an additional auxiliary trip signal TS1 can be obtained.

The operation of the low-set phase overcurrent stage I_> or the high-set phase overcurrent stage I_{>>} can be blocked by routing a blocking signal BS to the unit. The blocking configuration is set with switchgroup SGB.

The operation of the low-set phase overcurrent stage can be based on definite time or inverse time characteristic. The operation characteristic is selected with the SGF1/1...3 switches. At definite time operation characteristic the operate time t_> is set in seconds within the range, 0.05...300 s. When the inverse time operation characteristic (IDMT) is selected, four internationally standardized and two complementary time/current curves are available. The selector switches SGF1/1...3 are also used for selecting the desired operation characteristic.

Note!

The maximum continuous current carrying capacity of the energizing inputs is 4 x I_n, which must be observed when relay settings are calculated.

Note!

Because of the maximum measured current (63 x I_n), the setting value 2.5 is used for the IDMT calculation if the set value is greater than 2.5. This makes the operate time faster than the theoretical IDMT curve. However, the stage always starts according to the set value.

Note!

The operation of the low-set stage based on inverse time characteristic will be blocked¹⁾ by starting of the high-set stage. Then the operate time of the overcurrent unit is determined by the set operate time of the high-set stage at heavy fault currents.

¹⁾From program version 183 B and later this function can be switched off with switch 2 of the extended switchgroup, SGX. By default this function is switched off.

The setting range of the operate time t_{>>} of the high-set phase overcurrent stage is 0.04...300 s.

The operate signal of the two overcurrent stages is provided with a latching feature (switch SGB/6) which means that the operate signal TS2 is kept high after an operation, although the overcurrent stage resets. The latched TS2 signal is reset by pushing the RESET and PROGRAM push-buttons simultaneously or via the serial port using the command V101, see also chapter "Selector switches".

The set start current value I_{>>} of the high-set phase overcurrent stage can be doubled automatically on connection of the protected object to the network, i.e. at starting. In this way the start current of the high-set phase overcurrent stage can be given a lower value than the level of the connection inrush current. The automatic doubling function is selected with switch SGF1/5. The starting, which activates the doubling function, is defined as a situation where the phase currents rise from a value below 0.12 x I_> to a value exceeding 1.5 x I_> in less than 60 ms. The function stops when the currents fall below 1.25 x I_>.

The setting range of the start current of the high-set phase overcurrent stage is 0.5...40 x I_n. When the high-set stage is given a start current setting in the lower end of the setting range, the relay module will contain two almost identical overcurrent stages. This enables the overcurrent unit of the SPCJ 4D29 module to be used, for example, in two-stage load shedding applications.

The high-set phase overcurrent stage can be set out of operation with switch SGF2/5. When the high-set stage is set out of operation the display shows "- - -", indicating that the start current setting is infinite.

Earth-fault unit

The non-directional earth-fault unit of the relay module SPCJ 4D29 is a single-pole earth-fault unit. It contains two earth-fault stages, i.e. a low-set earth-fault stage $I_{0>}$ and a high-set earth-fault stage $I_{0>>}$.

The low-set or high-set earth-fault stage starts, if the measured current exceeds the set start current value. When the stage starts it generates a start signal SS1 or TS1 and simultaneously the digital display on the front panel indicates starting. If the earth-fault situation lasts long enough to exceed the set operate time, the stage operates and generates a trip signal TS2. At the same time the operation indicator TRIP is lit with red light. The red operation indicator remains lit although the stage resets. The indicator is reset by pushing the RESET push-button. By proper configuration of the output relay switchgroups an additional auxiliary trip signal TS1 can be obtained.

The operation of the low-set earth-fault stage $I_{0>}$ or the high-set earth-fault stage $I_{0>>}$ can be blocked by routing a blocking signal BS to the earth-fault unit. The blocking configuration is set with switchgroup SGB.

The operation of the low-set earth-fault stage can be based on definite time or inverse time characteristic. The operation characteristic is selected with the SGF/6...8 switches. At definite time operation characteristic the operate time $t_{0>}$ is directly set in seconds within the range, 0.05...300 s. When the inverse time operation characteristic (IDMT) is selected, four

internationally standardized and two complementary time/current curves are available. The selector switches SGF1/ 6...8 are also used for selecting the desired operation characteristic.

The setting range of the operate time $t_{0>>}$ of the high-set earth-fault stage is 0.05...300 s.

Note!

The operation of the low-set stage based on inverse time characteristic will be blocked¹⁾ by starting of the high-set stage. Then the operate time of the earth-fault unit is determined by the set operate time of the high-set stage at heavy fault currents.

1) From program version 183 B and later this function can be switched off with switch 2 of the extended switchgroup, SGX. By default this function is switched off.

The operate signal of the two earth-fault stages is provided with a latching feature (switch SGB/7) which means that the operate signal TS2 is kept high after an operation, although the earth-fault stage resets. The TS2 signal is reset by pushing the RESET and PROGRAM push-buttons simultaneously or via the serial port using the command V101, see chapter "Selector switches", page 9.

The high-set earth-fault stage can be set out of operation with switch SGF2/6. When the high-set stage is set out of operation the display shows "---", indicating that the start current setting is infinite.

Filter characteristics of the measuring inputs

A low-pass filter suppresses the harmonics of the phase currents and the earth-fault current meas-

ured by the module. Figure 1 and 2 shows the signal suppression as a function of the frequency.

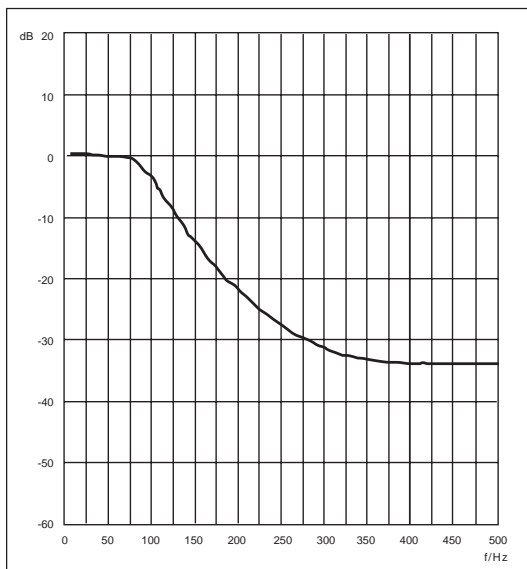

Fig. 1. Filter characteristics of the measuring inputs of the overcurrents for SPCJ 4D29.

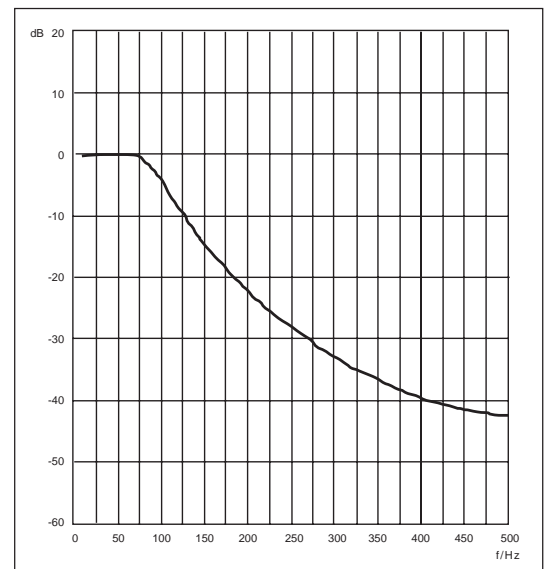

Fig. 2. Filter characteristics of the measuring input of the earth-fault current for SPCJ 4D29.

Circuit breaker failure protection unit

The relay module features a circuit breaker failure protection (CBFP) unit. The CBFP unit generates a trip signal via TS1 after a set operate time 0.1...1 s, following the main trip signal TS2, if the fault has not been cleared before the set operate time has elapsed. The output contact of the CBFP unit is normally used for tripping

an upstream circuit breaker. The CBFP unit can also be used for tripping via redundant trip circuits of the same circuit breaker, if the circuit breaker is provided with two trip coils. The circuit breaker failure protection unit is alerted/set out of operation with switch SGB1/4.

Remote setting

The relay can be given two sets of setting values, the main settings and the second settings. Switching between main settings and second settings can be done in three different ways, i) with a

command V150 via the serial port, ii) with a command via the external control input BS or manually by changing a parameter in submenu 4 of register A.

Block diagram

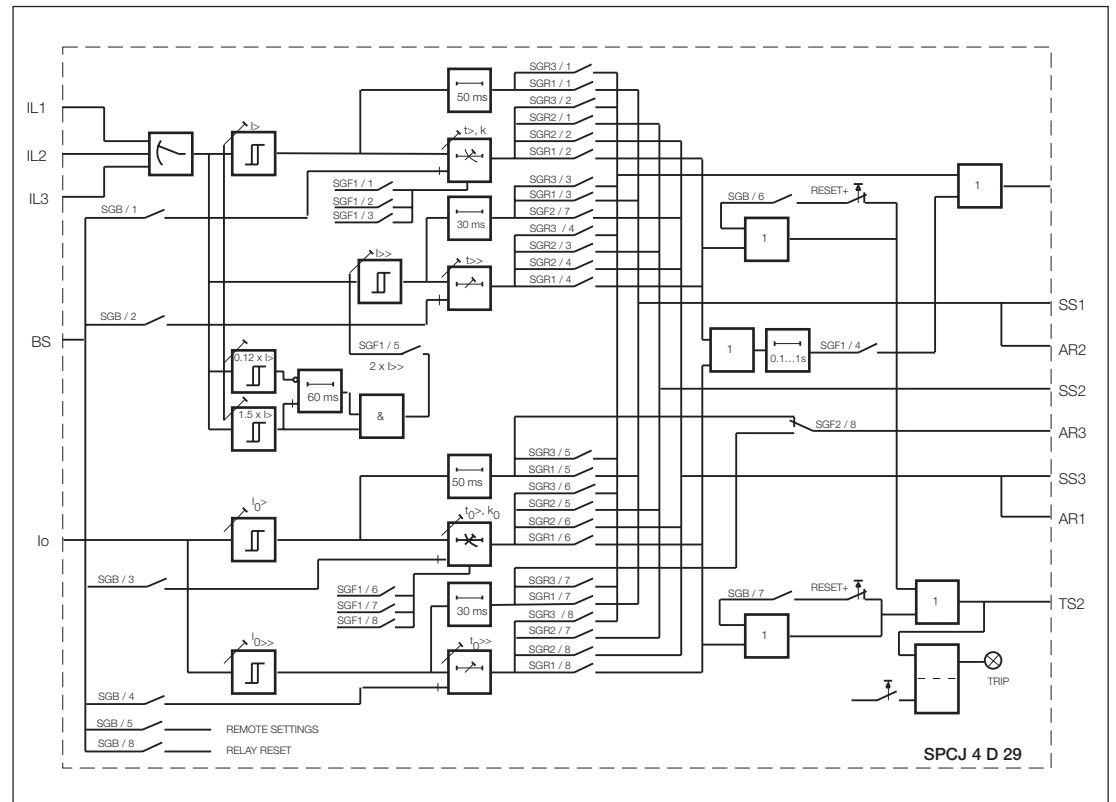

Fig. 3. Block diagram for the combined overcurrent and earth-fault relay module SPCJ 4D29.

I_{L1}, I_{L2}, I_{L3}	Energizing currents
I_0	Residual current
BS	External control signal
SGF1...2	Selector switchgroup SGF for operational relay functions
SGB	Selector switchgroup SGB for special relay functions
SGR1...3	Selector switchgroups SGR for configuration of output relays
TS1	Start signal 1 or auxiliary trip signal configured with switchgroup SGR3
SS1	Start signal configured with switchgroup SGR1
SS2	Trip signal 1 configured with switchgroup SGR2
SS3	Trip signal 2 configured with switchgroup SGR2
TS2	Trip signal configured with switchgroup SGR1
AR1, AR2, AR3	Start signals to possible external optional auto-reclose relays
TRIP	Red operation (trip) indicator

Note!

All input and output signals of the relay module are not necessarily wired to the terminals of a particular relay. The signals wired to the termi-

nals of a particular protection relay are shown in the signal diagram in the general part of the relay manual.

Front panel

Indicators for the measured phase currents I_{L1} , I_{L2} , I_{L3} and the residual current I_0

- Indicator for the start current of the $I>$ stage
- Indicator for the operate time $t>$ or time multiplier k of the $I>$ stage
- Indicator for the start current of the $I>>$ stage
- Indicator for the operate time of the $I>>$ stage
- Indicator for the start current of the $I_0>$ stage
- Indicator for the operate time $t_0>$ or time multiplier k_0 of the $I_0>$ stage
- Indicator for the start current of the $I_0>>$ stage
- Indicator for the operate time of the $I_0>>$ stage
- Indicator for the checksum of switchgroups SGF1...2
- Indicator for the checksum of switchgroup SGB
- Indicator for the checksum of switchgroups SGR1...3

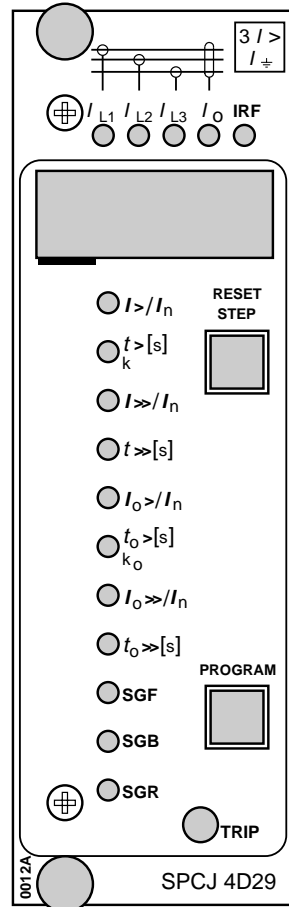
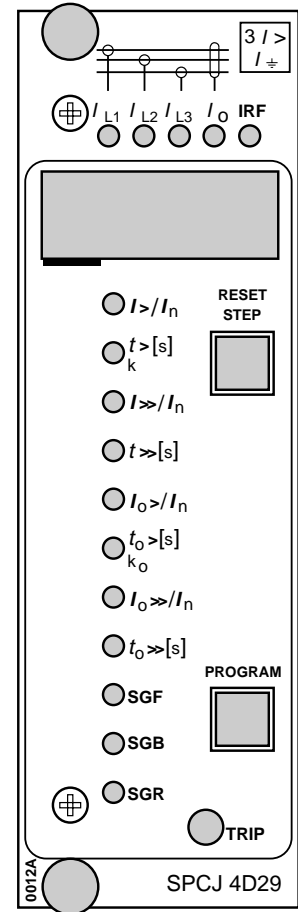

Relay module symbol

Self-supervision alarm indicator

Digital display

Reset and display step push-button

Selector push-button

TRIP indicator

Type designation of the module

Fig. 4. Front panel of the combined overcurrent and earth-fault relay module SPCJ 4D29.

Start and operation indicators

Both overcurrent stages have their own start indicators and operation indicators shown as figures on the digital display. Further, all the protection stages share a common red LED indicator marked "TRIP" which is located in the lower right corner of the front panel and which is lit on operation of a stage.

The figure on the display indicating starting or operation remains lit when the current stage resets, thus indicating which protection stage

has operated. The start or operation indicators are reset by pushing the RESET push-button. The function of the relay module is not affected by an unreset indicator. If the starting of a stage is short enough not to cause an operation of the relay, the start indication is normally self-reset when the stage resets. By means of switches SGF2/1...4 the start indicators can be configured for manual resetting. The following table shows a guide to the start and trip indicators of the relay module.

Indication	Explanation
1	I> START = the low-set stage I> of the overcurrent unit has started
2	I> TRIP = the low-set stage I> of the overcurrent unit has operated
3	I>> START = the high-set stage I>> of the overcurrent unit has started
4	I>> TRIP = the high-set stage I>> of the overcurrent unit has operated
5	I ₀ > START = the low-set stage I ₀ > of the earth-fault unit has started
6	I ₀ > TRIP = the low-set stage I ₀ > of the earth-fault unit has operated
7	I ₀ >> START = the high-set stage I ₀ >> of the earth-fault unit has started
8	I ₀ >> TRIP = the high-set stage I ₀ >> of the earth-fault unit has operated
9	CBFP = the circuit breaker failure protection has operated

When one of the protection stages of the relay module operates, the indicators for the energizing current of the module show the faulty phase, i.e. in which phase(s) the current has exceeded the set start value of the stage (so called phase fault indication). If, for instance, the operation indicator "2" of the low-set stage is lit, as are the indicators I_{L1} and I_{L2} also, the relay operation has been caused by overcurrent on the L1 and L2 phases. The fault indications are reset by pushing the RESET push-button.

The self-supervision alarm indicator IRF indicates, when lit, that the self-supervision system has detected a permanent internal relay fault. The indicator is lit with red light shortly after a fault has been detected. At the same time the relay module generates a control signal to the output relay of the self-supervision system IRF. Additionally, in most fault cases, an auto-diagnostic fault code showing the nature of the fault appears on the display. The fault code, consists of a red figure one (1) and a green code number. When a fault code is obtained it should be recorded for statistical and maintenance purposes.

Settings
(modified 2007-03)

The setting values are shown by the right-most three digits of the display. When lit, the LED indicators on the front panel adjacent to the symbol of the setting quantity shows the quantity currently being displayed.

$I_{>}/I_n$	Start current of the $I_{>}$ stage as a multiple of the rated current of the used energizing input. Setting range $0.5 \dots 5.0 \times I_n$ at definite time characteristic and $0.5 \dots 2.5 \times I_n$ at inverse time characteristic. Note! Because of the maximum measured current ($63 \times I_n$), the setting value 2.5 is used for the IDMT calculation if the set value is greater than 2.5. This makes the operate time faster than the theoretical IDMT curve. However, the stage always starts according to the set value.
$t_{>}$	Operate time of the $I_{>}$ stage expressed in seconds, at definite time characteristic (SGF1/1-2-3 = 0-0-0). Setting range 0.05...300 s.
k	Time multiplier of the $I_{>}$ stage at inverse time characteristic. Setting range 0.05...1.00.
$I_{>>}/I_n$	Start current of the $I_{>>}$ stage as a multiple of the rated current of the used energizing input. Setting range $0.5 \dots 40.0 \times I_n$. Additionally the setting "infinite" (displayed as n - - -) can be selected with switch SGF2/5, which means that the high-set stage $I_{>>}$ is out of operation.
$t_{>>}$	Operate time of the $I_{>>}$ stage expressed in seconds. Setting range 0.04...300 s.
$I_{0>}/I_n$	Start current of the $I_{0>}$ stage as a multiple of the rated current of the used energizing input. Setting range $0.1 \dots 0.8 \times I_n$.
$t_{0>}$	Operate time of the $I_{0>}$ stage, expressed in seconds, at definite time characteristic (SGF1/6-7-8 = 0-0-0). Setting range 0.05...300 s.
k_0	Time multiplier k_0 of the $I_{0>}$ stage at inverse time characteristic. Setting range 0.05...1.00.
$I_{0>>}/I_n$	Start current of the $I_{0>>}$ stage as a multiple of the rated current of the used energizing input. Setting range $0.1 \dots 10.0 \times I_n$. Additionally the setting "infinite" (displayed as n - - -) can be selected with switch SGF2/6, which means that the earth-fault stage $I_{0>>}$ is out of operation.
$t_{0>>}$	Operate time of the $I_{0>>}$ stage expressed in seconds. Setting range 0.05...300 s.

Further, the checksums of switchgroups SGF1, SGB and SGR1 are shown on the display when the indicators adjacent to the switchgroup symbols on the front panel are lit. The checksums for switchgroups SGF2, SGR2 and SGR3 are found in the submenus under the main menu of

the first switchgroup. For further information, see chapter "Menus and registers". An example of how the checksum can be calculated manually is given in manual "General characteristics of D type relay modules."

Selector switches
(modified 2007-03)

Additional functions required in various applications are selected with switchgroups SGF, SGB and SGR indicated on the front panel. Further, the relay module contains a software extended switchgroup SGX, which is located in submenu six of register A. The numbering of the

switches, 1...8, and the switch positions 0 and 1 are shown when the switchgroups are set. Under normal service conditions only the checksums are shown. Switchgroups SGF2, SGR2 and SGR3 are found in the submenus of the main menus of switchgroups SGF and SGR.

Function switch-
group SGF1

Switch	Function																																													
SGF1/1 SGF1/2 SGF1/3	<p>Switches SGF1/1...3 are used for selecting the characteristic of the low-set overcurrent stage I>, i.e. definite time operation characteristic or inverse definite minimum time (IDMT) characteristic. At IDMT characteristic the switches are also used for selecting the required current/time characteristic for the stage.</p> <table border="1"> <thead> <tr> <th>SGF1/1</th> <th>SGF1/2</th> <th>SGF1/3</th> <th>Characteristic</th> <th>Time or curve set</th> </tr> </thead> <tbody> <tr> <td>0</td> <td>0</td> <td>0</td> <td>Definite time</td> <td>0.05...300 s</td> </tr> <tr> <td>1</td> <td>0</td> <td>0</td> <td>IDMT</td> <td>Extremely inverse</td> </tr> <tr> <td>0</td> <td>1</td> <td>0</td> <td>IDMT</td> <td>Very inverse</td> </tr> <tr> <td>1</td> <td>1</td> <td>0</td> <td>IDMT</td> <td>Normal inverse</td> </tr> <tr> <td>0</td> <td>0</td> <td>1</td> <td>IDMT</td> <td>Long-time inverse</td> </tr> <tr> <td>1</td> <td>0</td> <td>1</td> <td>IDMT</td> <td>RI-characteristic</td> </tr> <tr> <td>0</td> <td>1</td> <td>1</td> <td>IDMT</td> <td>RXIDG-characteristic</td> </tr> <tr> <td>1</td> <td>1</td> <td>1</td> <td>IDMT</td> <td>Long-time inverse</td> </tr> </tbody> </table>	SGF1/1	SGF1/2	SGF1/3	Characteristic	Time or curve set	0	0	0	Definite time	0.05...300 s	1	0	0	IDMT	Extremely inverse	0	1	0	IDMT	Very inverse	1	1	0	IDMT	Normal inverse	0	0	1	IDMT	Long-time inverse	1	0	1	IDMT	RI-characteristic	0	1	1	IDMT	RXIDG-characteristic	1	1	1	IDMT	Long-time inverse
SGF1/1	SGF1/2	SGF1/3	Characteristic	Time or curve set																																										
0	0	0	Definite time	0.05...300 s																																										
1	0	0	IDMT	Extremely inverse																																										
0	1	0	IDMT	Very inverse																																										
1	1	0	IDMT	Normal inverse																																										
0	0	1	IDMT	Long-time inverse																																										
1	0	1	IDMT	RI-characteristic																																										
0	1	1	IDMT	RXIDG-characteristic																																										
1	1	1	IDMT	Long-time inverse																																										
SGF1/4	<p>Circuit breaker failure protection (CBFP).</p> <p>When SGF1/4 = 1 the trip signal TS2 will start a timer which will generate a delayed operate signal via TS1, if the fault has not been cleared before the operate time has elapsed.</p> <p>When switch SGF1/4 = 0 the circuit breaker failure protection is out of operation.</p>																																													
SGF1/5	<p>Automatic doubling of the set start current of the high-set overcurrent stage I>> when the protected object is energized.</p> <p>When SGF1/5 = 0, no doubling of the start current setting of stage I>> is obtained. When SGF1/5 = 1, the start current setting of stage I>> doubles automatically. The doubling feature makes it possible to give the high-set stage a setting value below the connection inrush current level.</p>																																													
SGF1/6 SGF1/7 SGF1/8	<p>Switches SGF1/6...8 are used for selecting the operation characteristic of the low-set earth-fault stage I₀>, i.e. definite time characteristic or inverse definite minimum time (IDMT) characteristic. At inverse definite minimum time characteristic the switches are also used for selecting the current/time characteristic of the stage.</p> <table border="1"> <thead> <tr> <th>SGF1/6</th> <th>SGF1/7</th> <th>SGF1/8</th> <th>Characteristic</th> <th>Time or curve</th> </tr> </thead> <tbody> <tr> <td>0</td> <td>0</td> <td>0</td> <td>Definite time</td> <td>0.05...300 s</td> </tr> <tr> <td>1</td> <td>0</td> <td>0</td> <td>IDMT</td> <td>Extremely inverse</td> </tr> <tr> <td>0</td> <td>1</td> <td>0</td> <td>IDMT</td> <td>Very inverse</td> </tr> <tr> <td>1</td> <td>1</td> <td>0</td> <td>IDMT</td> <td>Normal inverse</td> </tr> <tr> <td>0</td> <td>0</td> <td>1</td> <td>IDMT</td> <td>Long-time inverse</td> </tr> <tr> <td>1</td> <td>0</td> <td>1</td> <td>IDMT</td> <td>RI-characteristic</td> </tr> <tr> <td>0</td> <td>1</td> <td>1</td> <td>IDMT</td> <td>RXIDG-characteristic</td> </tr> <tr> <td>1</td> <td>1</td> <td>1</td> <td>IDMT</td> <td>Long-time inverse</td> </tr> </tbody> </table>	SGF1/6	SGF1/7	SGF1/8	Characteristic	Time or curve	0	0	0	Definite time	0.05...300 s	1	0	0	IDMT	Extremely inverse	0	1	0	IDMT	Very inverse	1	1	0	IDMT	Normal inverse	0	0	1	IDMT	Long-time inverse	1	0	1	IDMT	RI-characteristic	0	1	1	IDMT	RXIDG-characteristic	1	1	1	IDMT	Long-time inverse
SGF1/6	SGF1/7	SGF1/8	Characteristic	Time or curve																																										
0	0	0	Definite time	0.05...300 s																																										
1	0	0	IDMT	Extremely inverse																																										
0	1	0	IDMT	Very inverse																																										
1	1	0	IDMT	Normal inverse																																										
0	0	1	IDMT	Long-time inverse																																										
1	0	1	IDMT	RI-characteristic																																										
0	1	1	IDMT	RXIDG-characteristic																																										
1	1	1	IDMT	Long-time inverse																																										

On delivery from the factory all switches SGF1 are set at zero, i.e. the checksum for SGF1 is 0.

Function switch-
group SGF2

Switch	Function
SGF2/1 SGF2/2 SGF2/3 SGF2/4	<p>Switches SGF2/1...4 are used for selecting the operation characteristic of the start indicators of the different stages. When the switches are in position 0 the start signals are all automatically reset when the fault is cleared. To give the indicator of a stage the hand reset mode of operation, the corresponding switch is set in position 1:</p> <p>Note! When the switch is on, the LED indicators for measured phase(s) that caused the start are lit.</p> <p>SGF2/1 = 1 equals manual reset mode for the start indication of stage I> SGF2/2 = 1 equals manual reset mode for the start indication of stage I>> SGF2/3 = 1 equals manual reset mode for the start indication of stage I₀> SGF2/4 = 1 equals manual reset mode for the start indication of stage I₀>></p>
SGF2/5	<p>Operation of the high-set phase overcurrent stage I>>.</p> <p>When SGF2/5 = 0 the high-set stage I>> is alerted When SGF2/5 = 1 the high-set stage I>> is out of operation and the display shows " - - -"</p>
SGF2/6	<p>Operation of the high-set earth-fault stage I₀>>.</p> <p>When SGF2/6 = 0 the high-set stage I₀>> is alerted When SGF2/6 = 1 the high-set stage I₀>> is out of operation and the display shows " - - -"</p>
SGF2/7	<p>Start signal of the high-set stage I>> to the auto-reclose signal output AR1.</p> <p>When SGF2/7 = 1, the start signal of the I>> stage is routed to output AR1.</p> <p>Note! Outputs AR1 and SS3 are interconnected and they always carry the same signal. Therefore, if AR1 is used for starting auto-reclose functions, SS3 cannot be used for any other purpose.</p> <p>When SGF2/7 = 0, the start signal of the I>> stage is not routed to output AR1 nor SS3. Thus the signal output SS3 is available for other purposes.</p>
SGF2/8	<p>Start signal of the low-set stage I₀> or high-set stage I₀>> to auto-reclose signal output AR3.</p> <p>When SGF2/8 = 0 the start signal from the I₀> stage is routed to output AR3 When SGF2/8 = 1 the start signal from the I₀>> stage is routed to output AR3</p>

When the relay is delivered from the factory the SGF2 switches are set at zero, i.e. the checksum for SGF2 is 0.

Blocking or control signal configuration switchgroup SGB

Switch	Function
SGB/1 SGB/2 SGB/3 SGB/4	<p>Switches SGB/1...4 are used for routing an external blocking signal BS to one or more of the protection stages of the relay module. When the switches all are in position 0 no stage is blocked.</p> <p>When SGB/1 = 1 the I> stage is blocked by the external control signal BS When SGB/2 = 1 the I>> stage is blocked by the external control signal BS When SGB/3 = 1 the I₀> stage is blocked by the external control signal BS When SGB/4 = 1 the I₀>> stage is blocked by the external control signal BS</p>
SGB/5	<p>Selection of main settings or second settings with an external control signal BS or via the serial interface using command V150.</p> <p>When SGB/5 = 0 the settings can be controlled via the serial port but not via the external control input BS When SGB/5 = 1, the settings can be controlled via the external control input. The main values are enforced when the control input is not energized and the second settings are enforced when the control input is energized.</p> <p>Note! When the application includes switching between main and second settings, it should be noted that switch SGB/5 must have the same position in the main set of settings and the second set of settings. Otherwise a conflict situation might occur when the settings are switched by external control or via the serial port.</p>
SGB/6	<p>Latching of the trip signal TS2 of the phase overcurrent unit.</p> <p>When SGB/6 = 0 the trip signal returns to its initial state (= the output relay drops off), when the energizing signal causing the operation falls below the set start current. When SGB/6 = 1 the trip signal is latched (= the output relay remains picked up after operation), although the energizing signal falls below the start current. The trip signal is to be manually reset by pushing the push-buttons RESET and PROGRAM simultaneously. ¹⁾</p>
SGB/7	<p>Latching of the trip signal TS2 of the earth-fault unit.</p> <p>When SGB/7 = 0 the trip signal returns to its initial state (= the output relay drops off), when the measuring signal causing the operation falls below the set start current. When SGB/7 = 1 the trip signal is latched (= the output relay remains picked up after operation), although the energizing signal falls below the start current. The trip signal is to be manually reset by pushing the push-buttons RESET and PROGRAM simultaneously. ¹⁾</p>
SGB/8	<p>Remote resetting of a latched output relay and memorized values.</p> <p>When the output TS2 has been given the latching mode with switch SGB/6 or SGB/7, a remote reset can be performed using the external control input BS, when switch SGB/8 =1.</p>

When the relay is delivered from the factory the SGB switches are set at zero, i.e. the checksum for SGB is 0.

¹⁾ From the program versions 037F or 056A and later versions an additional feature has been incorporated into the relay module SPCJ 4D29. When the latching function is used the latched output can be reset by pushing the PROGRAM button alone, in which case the stored information of the module is not erased.

Output relay matrix
switchgroups SGR1,
SGR2 and SGR3

SGR1	The switches of switchgroup SGR1 are used to select the start and operate signals to be routed to outputs SS1 and TS2.
SGR2	The switches of switchgroup SGR2 are used for routing the operate signals of the protection stages to the outputs SS2 and SS3.
SGR3	The switches of switchgroup SGR3 are used to route the start and operate signals to the start or auxiliary trip output TS1. Note! If the circuit breaker failure protection has been taken in use with switch SGF1/4, it will also occupy the TS1 output.

Switch number	Function	Factory setting	Checksum value
SGR1/1	When SGR1/1 = 1, the start signal of the I> stage is routed to SS1	1	1
SGR1/2	When SGR1/2 = 1, the operate signal of the I> stage is routed to TS2	1	2
SGR1/3	When SGR1/3 = 1, the start signal of the I>> stage is routed to SS1	0	4
SGR1/4	When SGR1/4 = 1, the operate signal of the I>> stage is routed to TS2	1	8
SGR1/5	When SGR1/5 = 1, the start signal of the I ₀ > stage is routed to SS1	0	16
SGR1/6	When SGR1/6 = 1, the operate signal of the I ₀ > stage is routed to TS2	1	32
SGR1/7	When SGR1/7 = 1, the start signal of the I ₀ >> stage is routed to SS1	0	64
SGR1/8	When SGR1/8 = 1, the operate signal of the I ₀ >> stage is routed to TS2	1	128
Checksum for the factory settings of switchgroup SGR1			171

SGR2/1	When SGR2/1 = 1, the operate signal of the I> stage is routed to SS2	1	1
SGR2/2	When SGR2/2 = 1, the operate signal of the I> stage is routed to SS3	0	2
SGR2/3	When SGR2/3 = 1, the operate signal of the I>> stage is routed to SS2	1	4
SGR2/4	When SGR2/4 = 1, the operate signal of the I>> stage is routed to SS3	0	8
SGR2/5	When SGR2/5 = 1, the operate signal of the I ₀ > stage is routed to SS2	0	16
SGR2/6	When SGR2/6 = 1, the operate signal of the I ₀ > stage is routed to SS3	1	32
SGR2/7	When SGR2/7 = 1, the operate signal of the I ₀ >> stage is routed to SS2	0	64
SGR2/8	When SGR2/8 = 1, the operate signal of the I ₀ >> stage is routed to SS3	1	128
Checksum for the factory settings of switchgroup SGR2			165

Switch number	Function	Factory setting	Checksum value
SGR3/1	When SGR3/1 = 1, the start signal of the I> stage is routed to TS1	0	1
SGR3/2	When SGR3/2 = 1, the trip signal of the I> stage is routed to TS1	0	2
SGR3/3	When SGR3/3 = 1, the start signal of the I>> stage is routed to TS1	0	4
SGR3/4	When SGR3/4 = 1, the trip signal of the I>> stage is routed to TS1	0	8
SGR3/5	When SGR3/5 = 1, the start signal of the I ₀ > stage is routed to TS1	0	16
SGR3/6	When SGR3/6 = 1, the trip signal of the I ₀ > stage is routed to TS1	0	32
SGR3/7	When SGR3/7 = 1, the start signal of the I ₀ >> stage is routed to TS1	0	64
SGR3/8	When SGR3/8 = 1, the trip signal of the I ₀ >> stage is routed to TS1	0	128
Checksum for the factory settings of switchgroup SGR3			0

Extended switchgroup, SGX

The software extended switchgroup SGX located in the sixth submenu of register A.

Switch	Function	Factory setting	Checksum value
SGX/1	Non-volatile memory setting for recorded data 0 = recorded data is cleared at loss of auxiliary power 1 = recorded data remain at loss of auxiliary power	0	1
SGX/2	Blocking function of Inverse time operation of low set stage by the starting of high set stage 0 = Blocking function inhibited 1 = the inverse time of stage I> is blocked by I>> and inverse time of stage I ₀ > is blocked by I ₀ >>	0	2
SGX/3	Not used	0	4
SGX/4	Not used	0	8
SGX/5	Not used	0	16
SGX/6	Not used	0	32
SGX/7	Not used	0	64
SGX/8	Not used	0	128
Checksum for factory settings for SGX			0

Note! The extended switchgroup has been implemented from program version 183 B and later.

Measured data

The measured current values are shown by the three right-most digits of the display. The value displayed at the present time is indicated by a LED indicator on the front panel.

Indicator	Measured data
I_{L1}	Line current on phase L1 as a multiple of the rated current I_n of the used energizing input ($0 \dots 63 \times I_n$).
I_{L2}	Line current on phase L2 as a multiple of the rated current I_n of the used energizing input ($0 \dots 63 \times I_n$).
I_{L3}	Line current on phase L3 as a multiple of the rated current I_n of the used energizing input ($0 \dots 63 \times I_n$).
I_0	Residual current as a multiple of the rated current I_n of the used energizing input ($0 \dots 21 \times I_n$).

Recorded information

(modified 2007-03)

The left-most red digit shows the address of the register and the right-most three digits the recorded value. The relay records up to five events. This enables the user to analyze the last five fault conditions in the electrical power network. Each event includes for instance the measured currents and start durations. Additionally, information on the number of starts of the protection stages and demand current values is provided. The // symbol in the text indicates that the item following the symbol is found in a submenu.

Register/STEP	Recorded information
1	<p>Phase current I_{L1} displayed as a multiple of the rated current of the used input of the overcurrent unit. If the relay starts or operates, the current value at the moment of operation is recorded in a memory stack. Any new operation adds a new value to the stack and moves the old values one place forward. Five values are memorized. If a sixth value is recorded, the oldest value is lost.</p> <p>When the relay starts but does not operate, the relay module memorizes the maximum current measured on phase L1 during the start situation. When the stage operates¹⁾, the value of the current measured at the moment of operation is recorded</p> <p><i>1) From program version 183 B and later, five new submenu places 5...9 has been implemented. These new submenus records both at start or operation, the maximum value during the start situation of phase current L1.</i></p>
2	Phase current I_{L2} measured as a multiple of the rated current. The operation principle is the same as that of register 1.
3	Phase current I_{L3} measured as a multiple of the rated current. The operation principle is the same as that of register 1.
4	Maximum demand current value for a period of 15 minutes expressed in multiples of the rated current I_n of the used energizing input and based on the highest phase current. // Highest maximum demand current value recorded after the last relay reset.
5	Duration of the last start situation of the $I>$ stage as a percentage of the set operate time $t>$ or at IDMT characteristic the calculated operate time. At any new start the time counter starts from zero. Five start times are memorized. If a sixth start occurs the oldest start time is lost. When the concerned stage has operated, the counter reading is 100. // Number of starts of the low-set overcurrent stage $I>$, $n(I>) = 0 \dots 255$.
6	Duration of the last start situation of the $I>>$ stage as a percentage of the set operate time $t>>$. At any new start the time counter starts from zero. Five start times are memorized. If a sixth start occurs the oldest start time is lost. When the concerned stage has operated, the counter reading is 100. // Number of starts of the high-set overcurrent stage $I>>$, $n(I>>) = 0 \dots 255$.

Register/ STEP	Recorded information
7	Neutral current I_0 measured as a multiple of the rated current. The operation principle is the same as that of register 1.
8	Duration of the latest start situation of stage $I_{0>}$ as a percentage of the set operate time $t_{0>}$ or in IDMT operation characteristic the calculated operate time. At any new start the time counter starts from zero. Five start times are memorized. If a sixth start is recorded the oldest start time is lost. When the concerned stage has operated, the counter reading is 100. // Number of starts of the low-set earth-fault stage $I_{0>}$, $n(I_{0>}) = 0...255$.
9	Duration of the latest start situation of stage $I_{0>>}$ as a percentage of the set operate time $t_{0>>}$. At any new start the time counter starts from zero. Five start times are memorized. If a sixth start is recorded the oldest start time will be lost. When the concerned stage has operated, the counter reading is 100. // Number of starts of the high-set earth-fault stage $I_{0>>}$, $n(I_{0>>}) = 0...255$.
0	<p>Display of blocking signals and other external control signals. The right-most digit indicates the state of the blocking input of the module. The following states may be indicated: 0 = no blocking signal 1 = blocking or control signal BS active.</p> <p>The function of the external control signal on the relay unit is determined by the settings of switchgroup SGB</p> <p>From register "0" the TEST mode can be reached. In the TEST mode the start and trip signals of the relay module can be activated one by one. For further details see description "General characteristics of D type relay modules".</p>
A	<p>The address code of the protection relay module, required by the serial communication system. The address code is set at zero when no serial communication is to be used. The submenus of this register include the following settings or functions.</p> <ul style="list-style-type: none"> - 1st submenu. Selection of data transfer rate for the communication system. Selectable values 4800 Bd or 9600 Bd. - 2nd submenu. Bus communication monitor. If the relay is connected to bus communication unit, e.g. type SRIO 1000M, and the communication system is working properly, the monitor shows the value zero. When the communication system is out of operation the values 0...255 scroll in the monitor. - 3rd submenu. Password for allowing remote changing of setting values. The password must always be given via the serial port. - 4th submenu. Selection of main settings versus second settings. - 5th submenu. Setting of the operate time of the circuit breaker failure protection unit. - 6th submenu. Checksum of Extended switchgroup SGX. See chapter, selector switches.
-	Display dark. By pushing the STEP push-button the beginning of the display sequence is reached.

The registers 1...9 are set to zero by pressing the push-buttons RESET and PROGRAM simultaneously. The registers are also cleared if the auxiliary power supply is interrupted, except when $SGX/1 = 1$, i.e. recorded data remain at loss of auxiliary power. The address code of the

plug-in module, the data transfer rate of the serial communication and the password are not erased by a voltage failure. Instructions for setting the address and the data transfer are given in the manual "General characteristics of D-type SPC relay units".

Menu and register chart
(modified 2007-03)

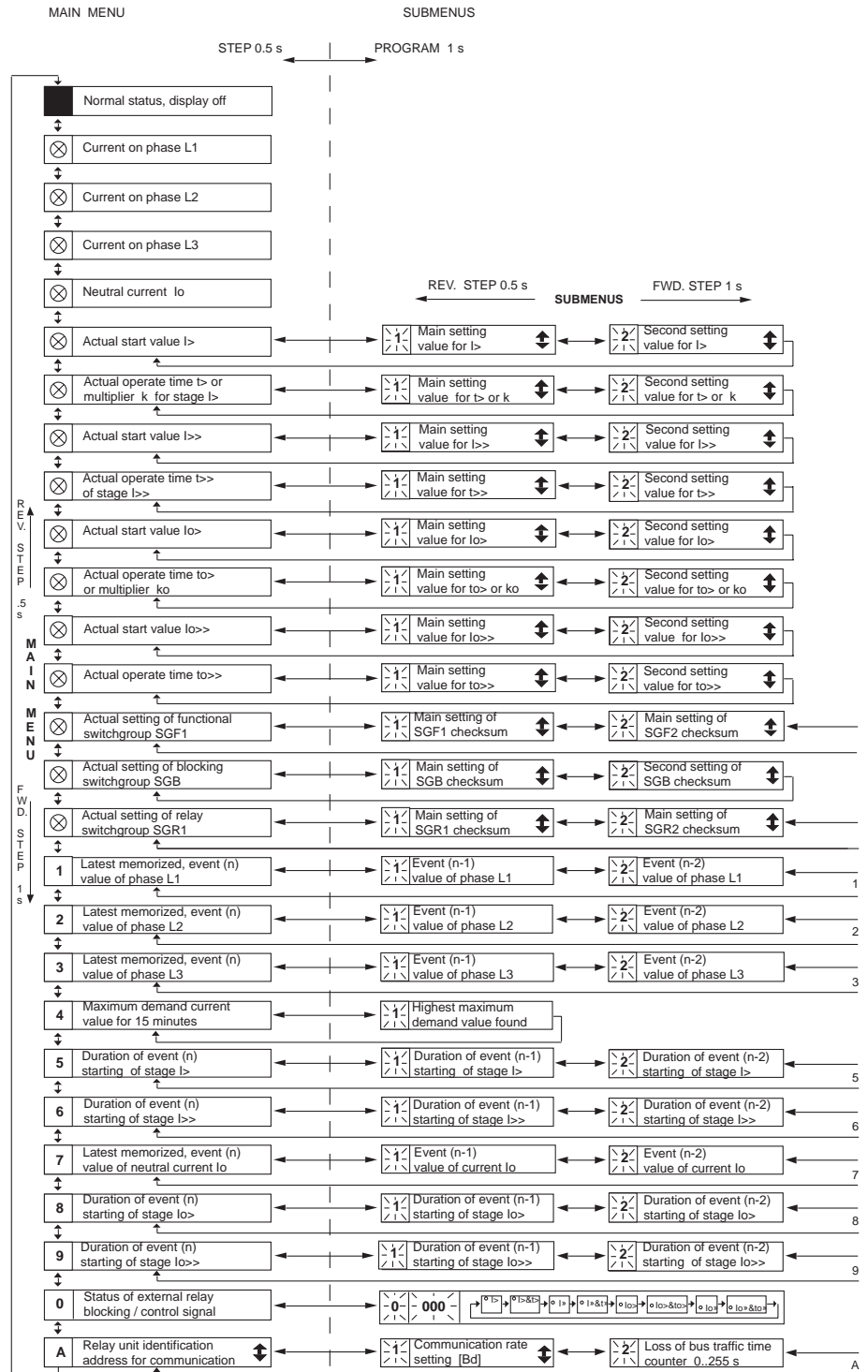

The procedures for entering a submenu or a setting mode and the method of performing the settings and the use of the TEST mode are described in detail in the manual "General characteristics of D type relay modules". A short form guide to the operations is shown below.

Desired step or setting operation	Push-button	Action
Forward step in main menu or submenu	STEP	Push for more than 0.5 s
Rapid scan forward in main menu	STEP	Keep pushing
Reverse step in main menu or submenu	STEP	Push less than about 0.5 s
Entering submenu from main menu	PROGRAM	Push for 1 s (Active on release)
Entering or leaving setting mode	PROGRAM	Push for 5 s
Increasing value in setting mode	STEP	
Moving the cursor in setting mode	PROGRAM	Push for about 1 s
Storing a value in setting mode	STEP&PROGRAM	Push simultaneously
Erasing of memorized values and resetting of latched output relays	STEP&PROGRAM	
Resetting of latched output relays	PROGRAM	Note! Display must be off

Note! All parameters which can be set in the setting mode are indicated with the symbol \updownarrow .

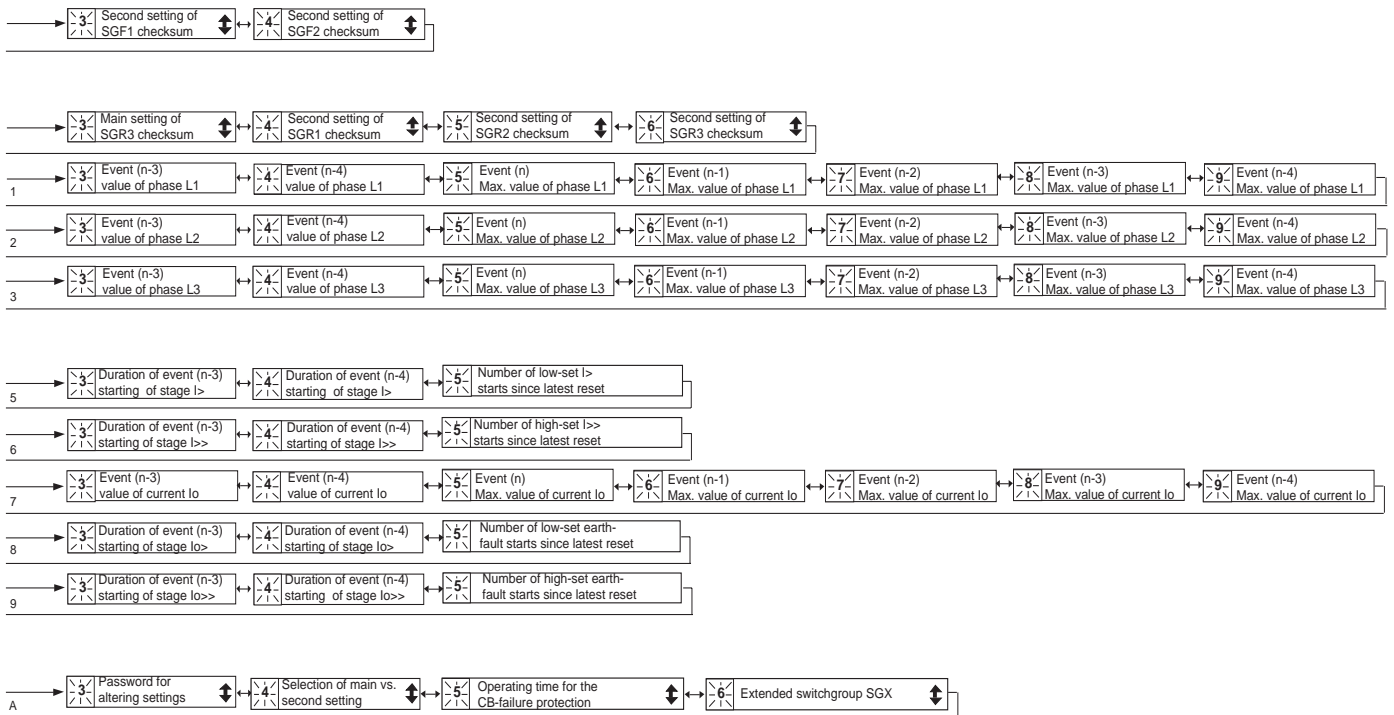

Time/current characteristic
(modified 2007-03)

The operation of the low-set overcurrent stage I_> and the low-set earth-fault stage I_{0>} is based on definite time or inverse time characteristic, as selected by the user. The operation characteristic is selected with switches 1...3 of switchgroup SGF1 for the overcurrent stage I_> and with switches SGF1/6...8 for the earth-fault stage I_{0>} (see chapter "Selector switches", page 7).

When IDMT characteristic has been selected, the operate time of the stage will be a function of the current; the higher the current, the shorter the operate time. The stage includes six time/current curve sets - four according to the BS 142 and IEC 60255 standards and two special curve sets, named RI type and RXIDG type, according to ABB standards.

IDMT characteristic

Four standard curves named extremely inverse, very inverse, normal inverse and long-time inverse are available. The relationship between current and time complies with the BS 142.1966 and IEC 60255-3 standards and can be expressed as follows:

$$t [s] = \frac{k \times \beta}{\left(\frac{I}{I_{>}}\right)^{\alpha} - 1}$$

where

- t = operate time in seconds
- k = time multiplier
- I = measured current value
- I_> = set start current value

The relay includes four time/current curve sets according to BS 142.1966 and IEC 60255-3.

The slope of the time/current curve sets is determined by the constants α and β as follows:

Slope of the time/current curve set	α	β
Normal inverse	0.02	0.14
Very inverse	1.0	13.5
Extremely inverse	2.0	80.0
Long-time inverse	1.0	120.0

According to the standard BS 142.1966 the normal current range is defined as 2...20 times the set start current. Additionally the relay must start at the latest when the current exceeds 1.3 times the set start current, when the time/current characteristic is normal inverse, very inverse or extremely inverse. At long-time inverse characteristic, the normal range is 2...7 times the set start current and the relay must start when the current exceeds 1.1 times the setting.

The following requirements with regard to operate time tolerances are specified in the standard (E denotes accuracy in per cent, - = not specified):

I/I _{>}	Normal inv.	Very inv.	Extremely inv.	Long-time inv.
2	2.22 E	2.34 E	2.44 E	2.34 E
5	1.13 E	1.26 E	1.48 E	1.26 E
7	-	-	-	1.00 E
10	1.01 E	1.01 E	1.02 E	-
20	1.00 E	1.00 E	1.00 E	-

In the defined normal current ranges, the inverse-time stages of the overcurrent and earth-fault unit SPCJ 4D29 comply with the tolerances of class 5 for all time/current curves.

The time/current curves specified in the BS-standards are illustrated in Fig. 5, 6, 7 and 8.

Note.

The actual operate time of the relay, presented in the graphs in Fig. 5...8, includes an additional filter and detection time plus the operate time of the trip output relay. When the operate time of the relay is calculated using the mathematical expression above, these additional times of about 30 ms in total have to be added to the time received.

<p>RI-type characteristic</p>	<p>The RI-type characteristic is a special characteristic used mainly in combination with existing mechanical relays. The characteristic is based on the following mathematical expression:</p> $t [s] = \frac{k}{0.339 - 0.236 \times \frac{I_{>}}{I}}$	<p>where</p> <p>t = operate time in seconds k = time multiplier I = measured phase current I> = set start current</p> <p>The graph of the characteristic is shown in Fig.9.</p>
<p>RXIDG-type characteristic</p>	<p>The RXIDG-type characteristic is a special characteristic used mainly for earth-fault protection, where a high degree of selectivity is needed also for high-resistance faults. With this characteristic, the protection relay need not to be directional and the scheme can operate without a pilot communication.</p>	<p>The characteristic is based on the following mathematical expression:</p> $t [s] = 5.8 - 1.35 \times \log_e \left(\frac{I}{k \times I_{>}} \right)$ <p>where</p> <p>t = operate time in seconds k = time multiplier I = measured phase current I> = set start current</p> <p>The graph of the characteristic is shown in Fig. 10.</p>
<p><i>Note!</i></p>	<p>If the set start current exceeds $2.5 \times I_n$, the maximum permitted continuous current carrying capacity of the energizing inputs ($4 \times I_n$) must be observed.</p> <p>Because of the maximum measured current ($63 \times I_n$), the setting value 2.5 is used for the IDMT calculation if the set value is greater than 2.5. This makes the operate time faster than the theoretical IDMT curve. However, the stage always starts according to the set value.</p>	<p>If the ratio between the current and the set start value is higher than 20, the operate time will be the same as when the ratio is 20.</p> <p>Note for RXIDG-type characteristic! If the ratio between the current and the set start value is higher than 40, the operate time will be the same as when the ratio is 40.</p> <p>The operation of the low-set stage based on inverse time characteristic will be blocked by starting of the high-set stage. Then the operate time of the overcurrent or earth-fault unit is determined by the set operate time of the high-set stage at heavy fault currents.</p>

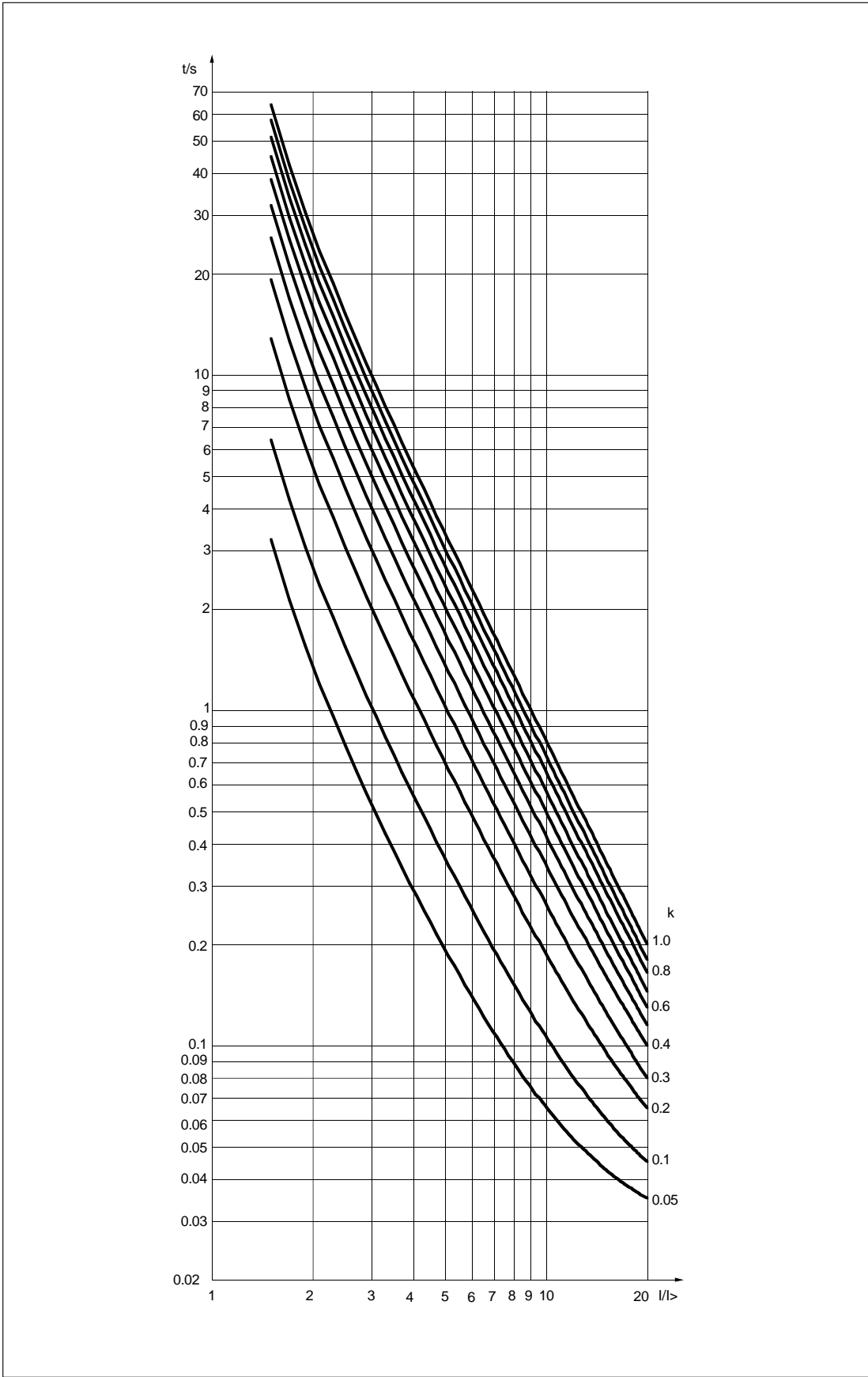

Fig. 5. Extremely inverse-time characteristics of the overcurrent and earth-fault unit SPCJ 4D29.

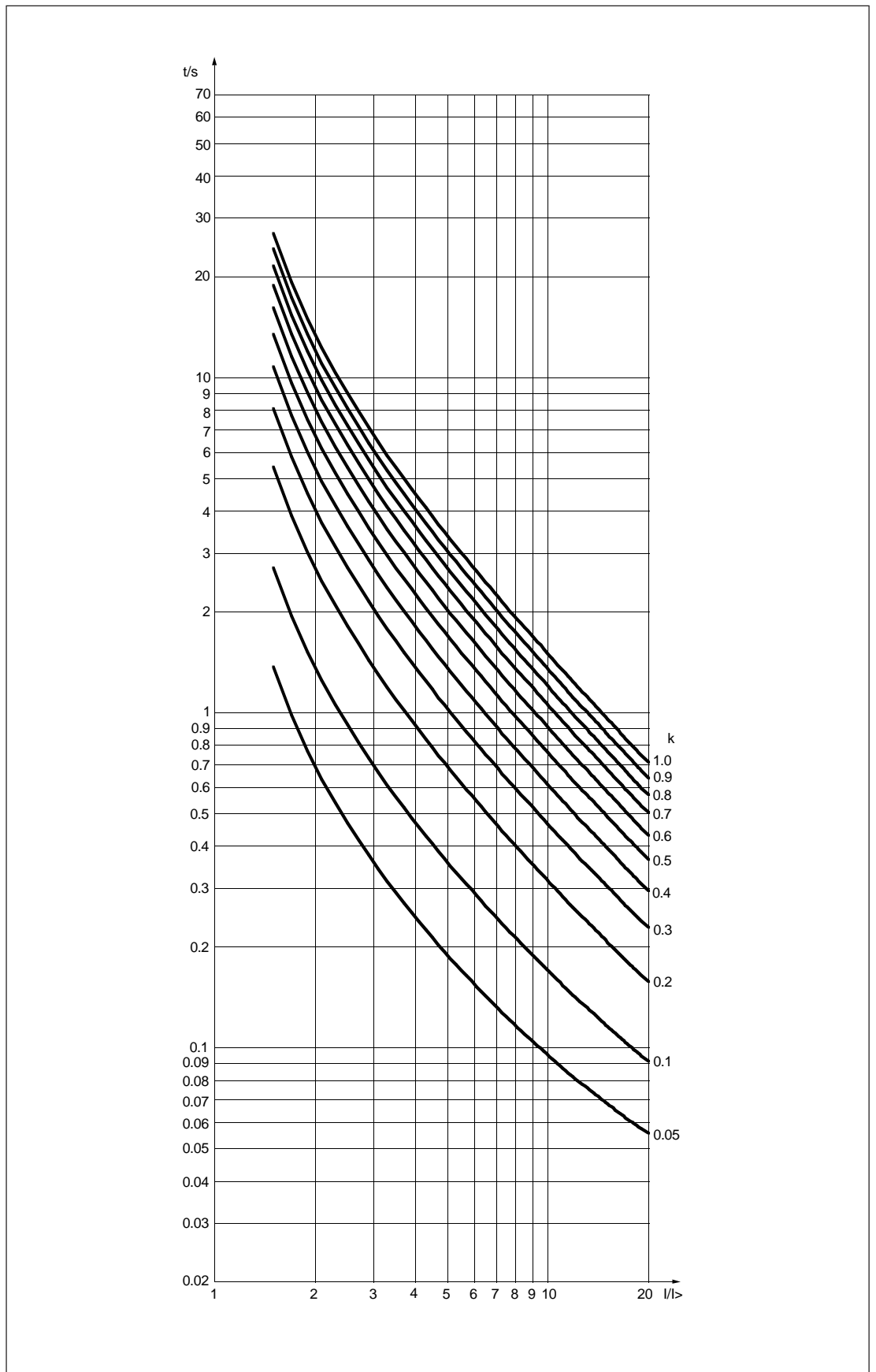

Fig. 6. Very inverse-time characteristics of the overcurrent and earth-fault unit SPCJ 4D29.

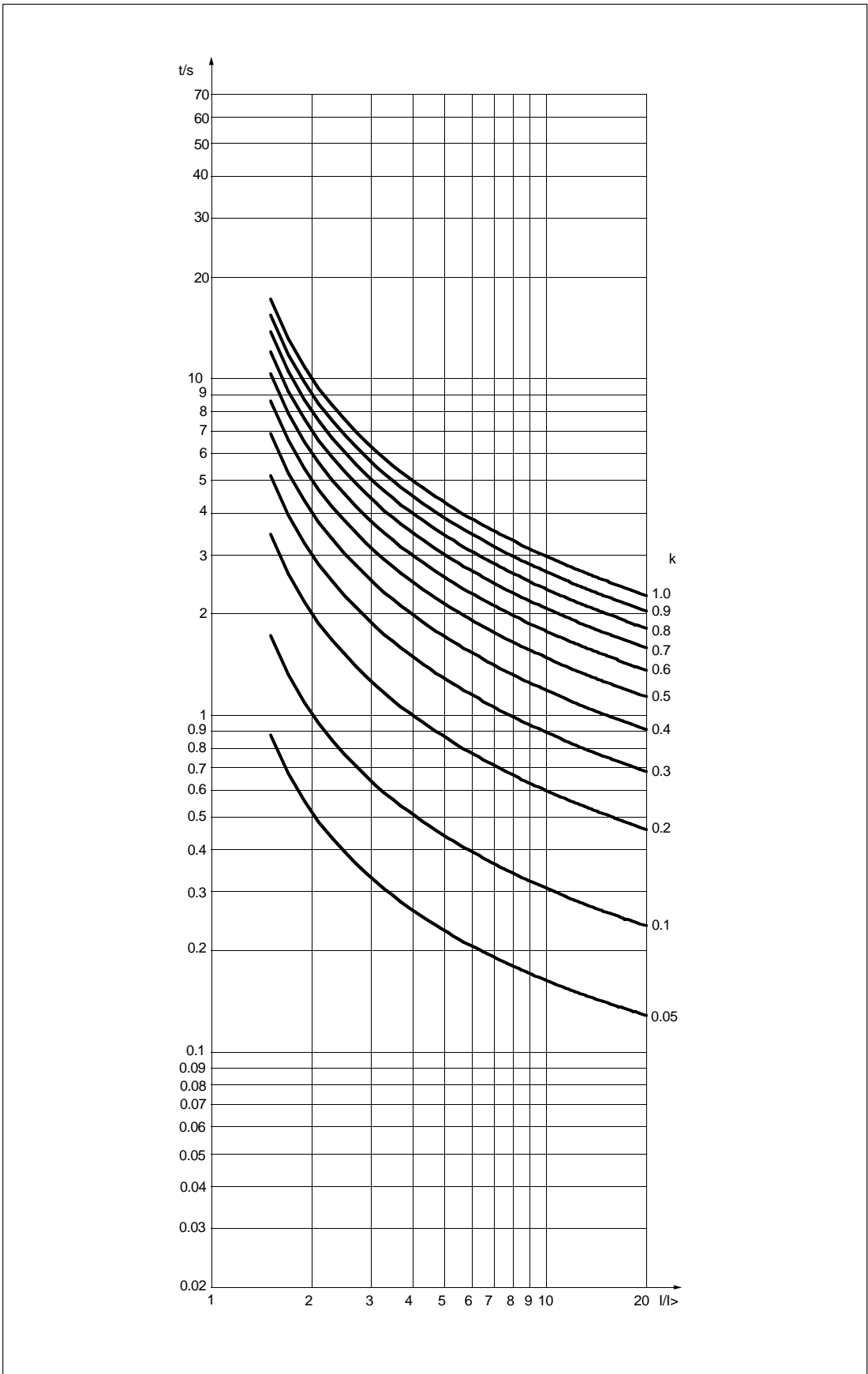

Fig. 7. Normal inverse-time characteristics of the overcurrent and earth-fault unit SPCJ 4D29.

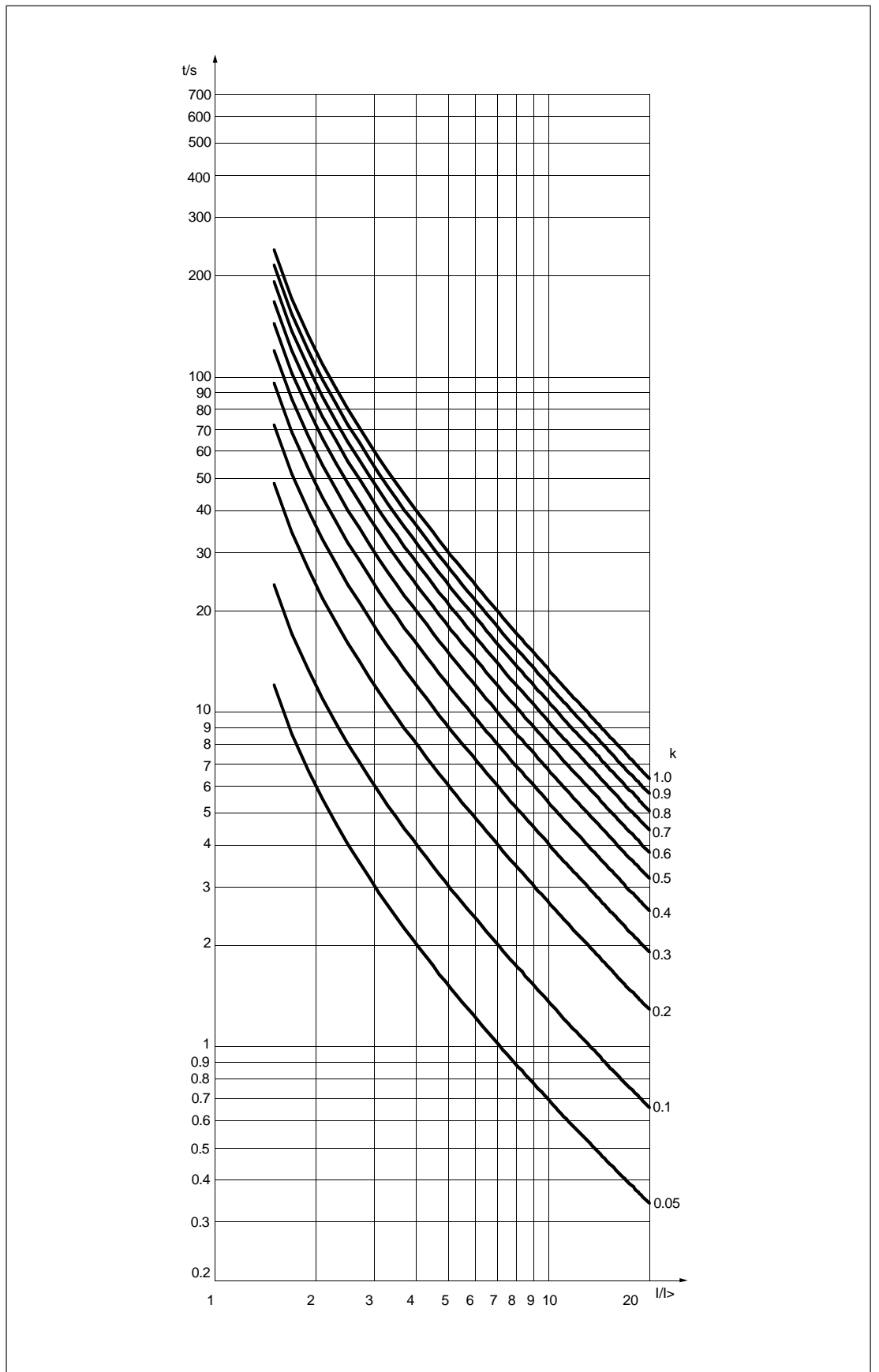

Fig. 8. Long-time inverse-time characteristics of the overcurrent and earth-fault unit SPCJ 4D29.

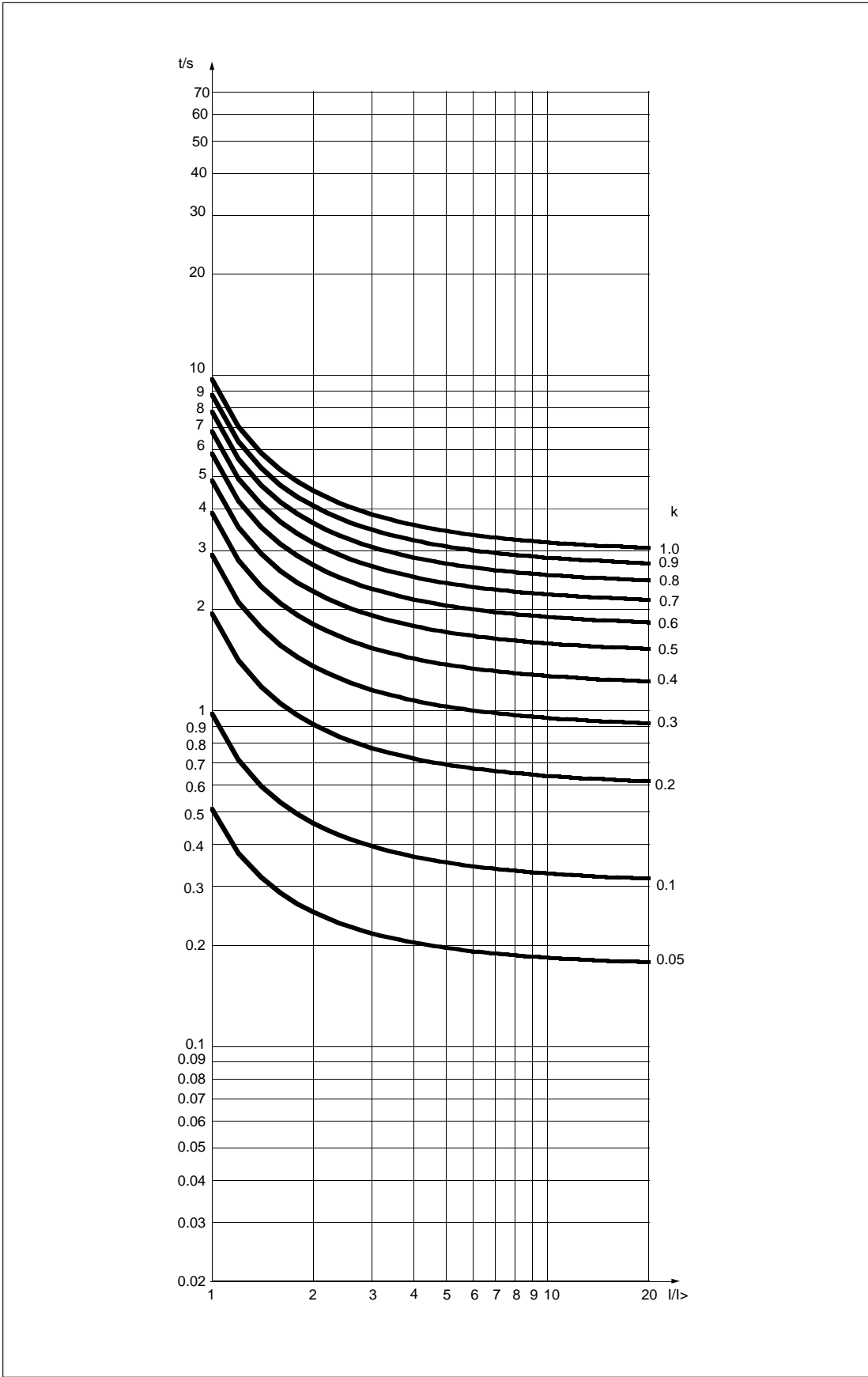

Fig. 9. RI-type inverse-time characteristics of the overcurrent and earth-fault unit SPCJ 4D29.

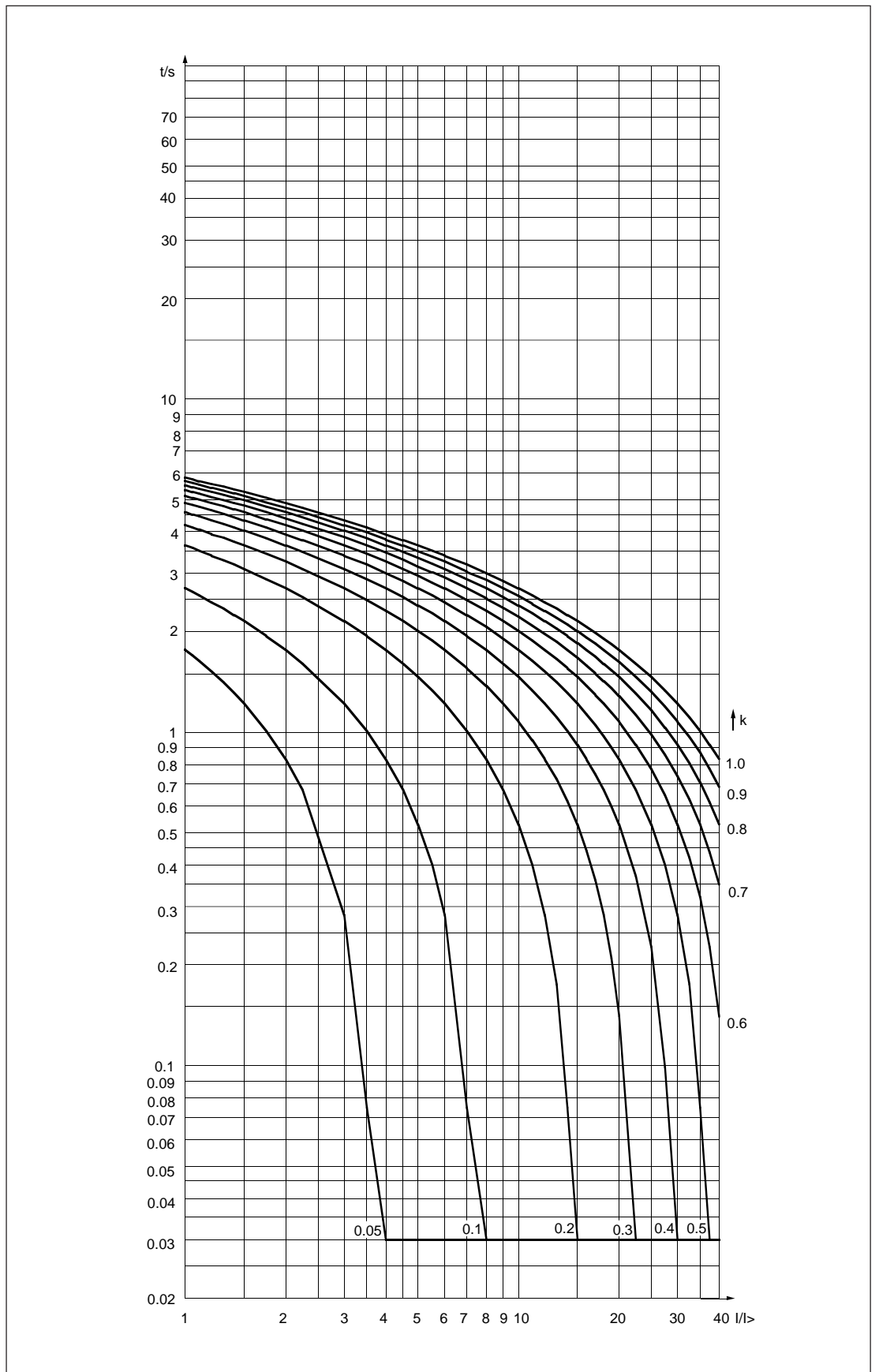

Fig. 10. RXIDG-type inverse-time characteristics of the overcurrent and earth-fault unit SPCJ 4D29.

Technical data
(modified 2007-03)

Low-set overcurrent stage I>

Start current	
- definite time characteristic	0.5...5.0 x I _n
- inverse time characteristic	0.5...2.5 x I _n
Start time, typ.	50 ms
Operation characteristic	
- definite time characteristic	
- operate time	0.05...300 s
- Inverse time characteristic acc. to BS 142 and IEC 60255-3	Extremely inverse Very inverse Normal inverse Long-time inverse
- special characteristic acc. to ABB standards	RI-type inverse RXIDG-type inverse
- time multiplier k	0.05...1.00
Reset time, typ.	40 ms
Retardation time	<30 ms
Drop-off/pick-up ratio, typ.	0.96
Operate time accuracy at definite time operation characteristic	±2 % of set value or ±25 ms
Operate time accuracy class E at inverse time characteristic	5
Operation accuracy	±3% of set value

High-set overcurrent stage I>>

Start current I>>	0.5...40.0 x I _n or ∞, infinite
Start time, typ.	40 ms
Operate time	0.04...300 s
Reset time, typ.	40 ms
Retardation time	<30 ms
Drop-off/pick-up ratio, typ.	0.96
Operate time accuracy	±2% of set value or ±25 ms
Operation accuracy	±3% of set value

Low-set earth-fault stage I₀>

Start current I ₀ >	0.1...0.8 x I _n
Start time, typ.	60 ms
Operation characteristic	
- definite time characteristic	
- operate time	0.05...300 s
- Inverse time characteristic acc. to BS 142 and IEC 60255-3	Extremely inverse Very inverse Normal inverse Long-time inverse
- special characteristic acc. to ABB standards	RI-type inverse RXIDG-type inverse
- time multiplier k ₀	0.05...1.00
Reset time, typ.	40 ms
Retardation time	<30 ms
Drop-off/pick-up ratio, typ.	0.96
Operate time accuracy at definite time operation characteristic	±2 % of set value or ±25 ms
Operate time accuracy class E at inverse time characteristic	5
Operation accuracy	±3% of set value

High-set earth-fault stage I₀>>

Start current I ₀ >>	0.1...10.0 x I _n or ∞, infinite
Start time, typ.	40 ms
Operate time	0.05...300 s
Reset time, typ.	40 ms
Drop-off/pick-up ratio, typ.	0.96
Operate time accuracy	±2% of set value or ±25 ms
Operation accuracy	±3% of set value

Serial communication parameters

Event codes

When the combined overcurrent and earth-fault relay module SPCJ 4D29 is connected to a data communication unit, e.g. SRIO 1000M, over a fibre-optic SPA bus, the module will spontaneously generate event markings e.g. for a printer. The events are printed out in the format: time, text and event code. The text can be defined and written by the user into the communication unit.

The events coded E1...E16 can be included in or excluded from the event reporting by writing an event mask V155 for the overcurrent events and V156 for earth-fault events to the module over the SPA bus. The event masks are binary numbers coded to decimal numbers. The event codes E1...E8 are represented by the numbers 1, 2, 4...128. An event mask is formed by multiplying the above numbers either by 0, event not included in reporting, or 1, event included in reporting and by adding the numbers received. Check for the procedure of a manual calculation of the checksum.

The event masks V155 and V156 may have a value within the range 0...255. The default value of the combined overcurrent and earth-fault relay module SPCJ 4D29 is 85 both for overcurrent and earth-fault events, which means that all start and operate events are included in the reporting, but not the resetting. Check for

the procedure of a manual calculation of the checksum.

The output signals are monitored by codes E17...E26 and these events can be included in or excluded from the event reporting by writing an event mask V157 to the module. The event mask is a binary number coded to a decimal number. The event codes E17...E26 are represented by the numbers 1, 2, 4...512. An event mask is formed by multiplying the above numbers either by 0, event not included in reporting or 1, event included in reporting and by adding the numbers received. Check for the procedure of a manual calculation of the checksum.

The event mask V157 may have a value within the range 0...1024. The default value of the combined overcurrent and earth-fault relay module SPCJ 4D29 is 768 which means that only the operations are included in the reporting.

Codes E50...E54 and the events represented by these cannot be excluded from the reporting.

More information about the serial communication over the SPA bus can be found in the manual "SPA bus communication protocol", code No 34 SPACOM 2 EN1.

Event codes of the combined overcurrent and earth-fault relay module SPCJ 4D29:

Code	Event	Weight factor	Default value of the factor
E1	Starting of stage I>	1	1
E2	Resetting of starting of stage I>	2	0
E3	Operation of stage I>	4	1
E4	Resetting of operation of stage I>	8	0
E5	Starting of stage I>>	16	1
E6	Resetting of starting of stage I>>	32	0
E7	Operation of stage I>>	64	1
E8	Resetting of operation of stage I>>	128	0
Default checksum for mask V155			85

Code	Event	Weight factor	Default value of the factor
E9	Starting of stage I ₀ >	1	1
E10	Resetting of starting of stage I ₀ >	2	0
E11	Operation of stage I ₀ >	4	1
E12	Resetting of operation of stage I ₀ >	8	0
E13	Starting of I ₀ >> stage	16	1
E14	Resetting of starting of stage I ₀ >>	32	0
E15	Operation of stage I ₀ >>	64	1
E16	Resetting of operation of stage I ₀ >>	128	0
Default checksum for mask V156			85

E17	Output signal TS1 activated	1	0
E18	Output signal TS1 reset	2	0
E19	Output signal SS1 activated	4	0
E20	Output signal SS1 reset	8	0
E21	Output signal SS2 activated	16	0
E22	Output signal SS2 reset	32	0
E23	Output signal SS3 activated	64	0
E24	Output signal SS3 reset	128	0
E25	Output signal TS2 activated	256	1
E26	Output signal TS2 reset	512	1
Default checksum for mask V157			768

E50	Restarting	*	-
E51	Overflow of event register	*	-
E52	Temporary interruption in data communication	*	-
E53	No response from the module over the data communication	*	-
E54	The module responds again over the data communication	*	-

- 0 not included in the event reporting
- 1 included in the event reporting
- * no code number
- cannot be programmed

Note!

The event codes E52-E54 are generated by the data communication unit (SACO 100M, SRIO 500M, SRIO 1000M, etc.)

Data to be transferred via the fibre-optic serial bus
(*modified 2007-03*)

In addition to the spontaneous data transfer the SPA bus allows reading of all input values (I-values), setting values (S-values), information recorded in the memory (V-values), and some other data. Further, part of the data can be altered by commands given over the SPA bus.

All the data are available in channel 0.

R = data to be read from the unit

W = data to be written to the unit

(P) = writing enabled by password

Data	Code	Data direction	Values
INPUTS			
Current on phase L1	I1	R	0...63 x I _n
Current on phase L2	I2	R	0...63 x I _n
Current on phase L3	I3	R	0...63 x I _n
Neutral current	I4	R	0...21 x I _n
Blocking or control signal	I5	R	0 = no blocking 1 = external blocking or control signal active
OUTPUTS			
Starting of stage I>	O1	R	0 = I> stage not started 1 = I> stage started
Operation of stage I>	O2	R	0 = I> stage not tripped 1 = I> stage tripped
Starting of stage I>>	O3	R	0 = I>> stage not started 1 = I>> stage started
Operation of stage I>>	O4	R	0 = I>> stage not tripped 1 = I>> stage tripped
Starting of stage I ₀ >	O5	R	0 = I ₀ > stage not started 1 = I ₀ > stage started
Operation of stage I ₀ >	O6	R	0 = I ₀ > stage not tripped 1 = I ₀ > stage tripped
Starting of stage I ₀ >>	O7	R	0 = I ₀ >> stage not started 1 = I ₀ >> stage started
Operation of stage I ₀ >>	O8	R	0 = I ₀ >> stage not tripped 1 = I ₀ >> stage tripped
Signal START1 TS1	O9	R, W (P)	0 = signal not active 1 = signal active
Signal START2 SS1	O10	R, W (P)	0 = signal not active 1 = signal active
Signal ALARM1 SS2	O11	R, W (P)	0 = signal not active 1 = signal active
Signal ALARM2 SS3	O12	R, W (P)	0 = signal not active 1 = signal active
Signal TRIP TS2	O13	R, W (P)	0 = signal not active 1 = signal active
Operate output relays	O41	R, W (P)	0 = not operated 1 = operated

Data	Code	Data direction	Values
Memorized I> start signal	O21	R	0 = signal not active 1 = signal active
Memorized I> operate signal	O22	R	0 = signal not active 1 = signal active
Memorized I>> start signal	O23	R	0 = signal not active 1 = signal active
Memorized I>> operate signal	O24	R	0 = signal not active 1 = signal active
Memorized I ₀ > start signal	O25	R	0 = signal not active 1 = signal active
Memorized I ₀ > operate signal	O26	R	0 = signal not active 1 = signal active
Memorized I ₀ >> start signal	O27	R	0 = signal not active 1 = signal active
Memorized I ₀ >> operate signal	O28	R	0 = signal not active 1 = signal active
Memorized output signal TS1	O29	R	0 = signal not active 1 = signal active
Memorized output signal SS1	O30	R	0 = signal not active 1 = signal active
Memorized output signal SS2	O31	R	0 = signal not active 1 = signal active
Memorized output signal SS3	O32	R	0 = signal not active 1 = signal active
Memorized output signal TS2	O33	R	0 = signal not active 1 = signal active

PRESENT SETTING VALUES

Present start value for stage I>	S1	R	0.5...5.0 x I _n
Present operate time or time multiplier for stage I>	S2	R	0.05...300 s 0.05...1.0
Present start value for stage I>>	S3	R	0.5...40 x I _n 999 = not in use (∞)
Present operate time for stage I>>	S4	R	0.04...300 s
Present start value for stage I ₀ >	S5	R	0.1...0.8 x I _n
Present operate time or time multiplier for stage I ₀ >	S6	R	0.05...300 s 0.05...1.0
Present start value for stage I ₀ >>	S7	R	0.1...10.0 x I _n 999 = not in use (∞)
Present operate time for stage I ₀ >>	S8	R	0.05...300 s
Present checksum of switchgroup SGF1	S9	R	0...255
Present checksum of switchgroup SGF2	S10	R	0...255
Present checksum of switchgroup SGB	S11	R	0...255
Present checksum of switchgroup SGR1	S12	R	0...255
Present checksum of switchgroup SGR2	S13	R	0...255
Present checksum of switchgroup SGR3	S14	R	0...255

Data	Code	Data direction	Values
MAIN SETTING VALUES			
Start current of stage I>, main setting	S21	R, W (P)	0.5...5.0 x I _n
Operate time or time multiplier of stage I>, main setting	S22	R, W (P)	0.05...300 s 0.05...1.0
Start current of stage I>>, main setting	S23	R, W (P)	0.5...40.0 x I _n
Operate time of stage I>>, main setting	S24	R, W (P)	0.04...300 s
Start current of stage I ₀ >, main setting	S25	R, W (P)	0.1...0.8 x I _n
Operate time or time multiplier of stage I ₀ >, main setting	S26	R, W (P)	0.05...300 s 0.05...1.0
Start current of stage I ₀ >>, main setting	S27	R, W (P)	0.1...10.0 x I _n
Operate time of stage I ₀ >>, main setting	S28	R, W (P)	0.05...300 s
Checksum of switchgroup SGF1, main setting	S29	R, W (P)	0...255
Checksum of switchgroup SGF2, main setting	S30	R, W (P)	0...255
Checksum of switchgroup SGB, main setting	S31	R, W (P)	0...255
Checksum of switchgroup SGR1, main setting	S32	R, W (P)	0...255
Checksum of switchgroup SGR2, main setting	S33	R, W (P)	0...255
Checksum of switchgroup SGR3, main setting	S34	R, W (P)	0...255
SECOND SETTING VALUES			
Start current of stage I>, second setting	S41	R, W (P)	0.5...5.0 x I _n
Operate time or time multiplier of stage I>, second setting	S42	R, W (P)	0.05...300 s 0.05...1.0
Start current of stage I>>, second setting	S43	R, W (P)	0.5...40.0 x I _n
Operate time of stage I>>, second setting	S44	R, W (P)	0.04...300 s
Start current of stage I ₀ >, second setting	S45	R, W (P)	0.1...0.8 x I _n
Operate time or time multiplier of stage I ₀ >, second setting	S46	R, W (P)	0.05...300 s 0.05...1.0
Start current of stage I ₀ >>, second setting	S47	R, W (P)	0.1...10.0 x I _n
Operate time of stage I ₀ >>, second setting	S48	R, W (P)	0.05...300 s
Checksum of switchgroup SGF1, second setting	S49	R, W (P)	0...255
Checksum of switchgroup SGF2, second setting	S50	R, W (P)	0...255
Checksum of switchgroup SGB, second setting	S51	R, W (P)	0...255

Data	Code	Data direction	Values
Checksum of switchgroup SGR1, second setting	S52	R, W (P)	0...255
Checksum of switchgroup SGR2, second setting	S53	R, W (P)	0...255
Checksum of switchgroup SGR3, second setting	S54	R, W (P)	0...255
Operate time for the circuit breaker failure protection	S61	R, W (P)	0.1...1.0 s

RECORDED AND MEMORIZED PARAMETERS

Current on phase L1 at starting or operation	V11, V21, V31, V41, V51	R	0...63 x I _n
Current on phase L2 at starting or operation	V12, V22, V32, V42, V52	R	0...63 x I _n
Current on phase L3 at starting or operation	V13, V23, V33, V43, V53	R	0...63 x I _n
Neutral current I ₀ at starting or operation	V14, V24, V34, V44, V54	R	0...21 x I _n
Duration of the latest start situation of stage I>	V15, V25, V35, V45, V55	R	0...100%
Duration of the latest start situation of stage I>>	V16, V26, V36, V46, V56	R	0...100%
Duration of the latest start situation of stage I ₀ >	V17, V27, V37, V47, V57	R	0...100%
Duration of the latest start situation of stage I ₀ >>	V18, V28, V38, V48, V58	R	0...100%
Maximum value of phase L1	V211, V221, V231, V241, V251	R	0...63 x I _n
Maximum value of phase L2	V212, V222, V232, V242, V252	R	0...63 x I _n
Maximum value of phase L3	V213, V223, V233, V243, V253	R	0...63 x I _n
Maximum value of neutral current I ₀	V214, V224, V234, V244, V254	R	0...21 x I _n
Maximum demand current for 15 min.	V1	R	0...2.5 x I _n
Number of starts of stage I>	V2	R	0...255
Number of starts of stage I>>	V3	R	0...255
Number of starts of stage I ₀ >	V4	R	0...255
Number of starts of stage I ₀ >>	V5	R	0...255
Phase conditions during trip	V6	R	1 = I _{L3} >, 2 = I _{L2} >, 4 = I _{L1} >, 8 = I ₀ > 16 = I _{L3} >>, 32 = I _{L2} >>, 64 = I _{L1} >>, 128 = I ₀ >>
Operation indicator	V7	R	0...9
Highest maximum demand current 15 minute value	V8	R	0...2.55 x I _n

Data	Code	Data direction	Values
CONTROL PARAMETERS			
Resetting of output relays at latched output	V101	W	1 = output relays and all information from the display are reset
Resetting of output relays and recorded data	V102	W	1 = output relays and registers are reset
Remote control of settings	V150	R, W	0 = main settings activated 1 = second settings activated, see chapter "Description of function"
Extended switchgroup SGX	V152	R/W(P)	0..3
Event mask word for overcurrent events	V155	R, W	0...255, see chapter "Event codes"
Event mask word for earth-fault events	V156	R, W	0...255, see chapter "Event codes"
Event mask word for output signal events	V157	R, W	0...1023, see chapter "Event codes"
Opening of password for remote settings	V160	W	1...999
Changing or closing of password for remote settings	V161	W (P)	0...999
Activating of self-supervision output	V165	W	1 = self-supervision output is activated and IRF LED turned on 0 = normal mode
EEPROM formatting (will restore factory settings)	V167	W (P)	2 = formatting, to be followed by power reset
Internal fault code	V169	R	0...255
Data comm. address of the module	V200	R, W	1...254
Data transfer rate	V201	R, W	4800 or 9600 Bd (R) 4.8 or 9.6 kBd (W)
Software version symbol	V205	R	037_ or 056_
Event register reading	L	R	time, channel number and event code
Re-reading of event register	B	R	time, channel number and event code
Type designation of the module	F	R	SPCJ 4D29
Reading of module status data	C	R	0 = normal state 1 = module been subject to automatic reset 2 = overflow of event regist. 3 = events 1 and 2 together
Resetting of module state data	C	W	0 = resetting
Time reading and setting	T	R, W	00.000...59.999 s

The event register can be read by L-command only once. Should a fault occur e.g. in the data transfer, the contents of the event register may be re-read using the B-command. When required, the B-command can be repeated. Generally, the control data communicator SACO 100M reads the event data and forwards them to the output device continuously. Under normal conditions the event register of the module is empty. The data communicator also resets abnormal status data, so this data is normally a zero.

The setting values S1...S14 are the setting values used by the protection functions. All the settings can be read or written. A condition for writing is that remote set password has been opened.

When changing settings, the relay unit will check that the variable values are within the ranges specified in the technical data of the module. If a value beyond the limits is given to the unit, either manually or by remote setting, the unit will not perform the store operation but will keep the previous setting.

Fault codes

Shortly after the internal self-supervision system has detected a permanent relay fault, the red IRF indicator is lit and the output relay of the self-supervision system operates. Further, in most fault situations, an auto-diagnostic fault code is shown on the display. This fault code consists of a red figure 1 and a green code number which

indicates the fault type. When a fault code appears on the display, the code number should be recorded and given to the authorized repair shop when overhaul is ordered. In the table below some fault codes that might appear on the display of the SPCJ 4D29 module are listed:

Fault code	Type of error in module
4	Faulty trip relay path or missing output relay card
30	Faulty program memory (ROM)
50	Faulty work memory (RAM)
51	Parameter memory (EEPROM) block 1 faulty
52	Parameter memory (EEPROM) block 2 faulty
53	Parameter memory (EEPROM) block 1 and block 2 faulty
54	Parameter memory (EEPROM) block 1 and block 2 faulty with different checksums
56	Parameter memory (EEPROM) key faulty. Format by writing a "2" to variable V167
195	Too low value in reference channel with multiplier 1
131	Too low value in reference channel with multiplier 5
67	Too low value in reference channel with multiplier 25
203	Too high value in reference channel with multiplier 1
139	Too high value in reference channel with multiplier 5
75	Too high value in reference channel with multiplier 25
252	Faulty filter on I ₀ channel
253	No interruptions from the A/D-converter



ABB Oy, Distribution Automation
P.O. Box 699
FIN-65101 VAASA, Finland
Tel. +358 10 22 11
Fax. +358 10 22 41094
www.abb.com/substationautomation

ABB Limited, Distribution Automation
Maneja, Vadodara - 390013, India
Tel. +91 265 260 4386
Fax. +91 265 263 8922
www.abb.com/substationautomation